

Manufacturers of specialist surgical instruments



SINGLE USE PRODUCT CATALOGUE



Manufacturers of specialist surgical instruments

We are **Surgitrac® Instruments** a multinational manufacturer and distributor of specialist surgical instruments for use in Ophthalmology.

Our manufacturing site is ISO 13485:2016 certified.

Surgitrac Instruments UK is ISO 13485: 2016 and EN ISO 13485:2016 certified.

We offer:

- Quality assured CE marked products, manufactured to internationally recognised standards.
- Transparency in our supply chain, no forced, or child labour is used during our manufacturing.
- A continuous supply of products, due to our capacity to manufacture millions of instruments each year.

We are specialists in single-use instruments

Ophthalmic instruments arrive sterile, and ready to use.

We offer any combination of instruments assembled as sterile, sets and procedure packs.

Procedure packs include a selection of instruments and associated items such as drapes, swabs and gallipots.

Instruments sets include two or more items, sterile and in a convenient wrap or tray ready to use.

Packs that we offer include:

Cataract | DMEK basic | DMEK complete | Eye bank | Cross Linking | Lasek | Lasik | Intravitreal injection (IVT)
Vitreoretinal (VR) | Lacrimal wash-out | Chalazion | Sub -tenon anaesthesia.

Sets that we offer include:

Cataract | Glaucoma | Pterygium | Biopsy & minor procedure | Eye lid surgery | Plastic surgery
Sub tenon anaesthesia | Strabismus | Retina of Prematurity (ROP) | Eye bank

Non sterile bulk wholesale

Our instruments are available for bulk wholesale. Instruments are supplied packed and ready for sterilisation. We can offer private label manufacturing through our OEM business. Precision instruments featuring your brand can be supplied as single-use sterile or as non-sterile units.

Contact us info@surgitrac.com more information.

Using this catalogue

This catalogue is designed to provide specific information about our products and their technical specifications.

Product details

Product code number – Single use S codes.



■ Single Use Instrument Code

Capsulorhexis forceps cross action - SC33

Length: 11.5 cm
Handle length: 82 mm
50° angles platform



Description details product specifications such as handle length.

Product images are not shown at actual size.

The technical illustration specifies details such as tip measurements.

Detailed technical files for instruments are available at request.

CONTENTS:

Page 2: About

Page 4: User guide

Page 5: Contents

Page 6: Forceps

Page 18: Manipulators and Choppers

Page 24: Speculums

Page 30: Scissors

Page 36: General ophthalmic

Page 43: Corneal and Refractive

Page 52: Measurers and Markers

Page 56: Curettes and Clamps

Page 59: Needle holders

Page 61: Lacrimal

Page 64: Index

Forceps

Capsulorhexis | Fixation | General | Lens | Tying



Single Use Instrument Code

Capsulorhexis forceps cross action - SC33

Length: 11.5 cm
 Handle length: 82 mm
 50° angled platform tips 0.3 mm

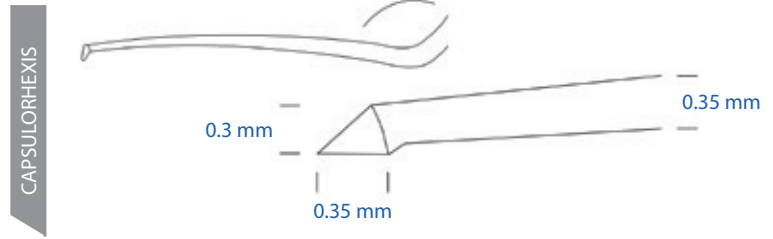

Capsulorhexis forceps cross action no tips - SC154

Length: 11.7cm
 Handle length: 85 mm

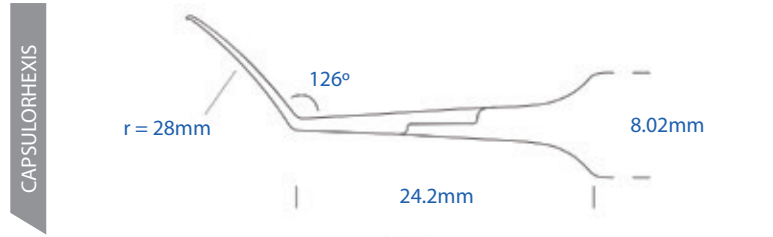

Capsulorhexis forceps curved - SC32

Length: 10.5 mm
 Handle length: 75 mm
 45° angled platform with tips 0.3 mm

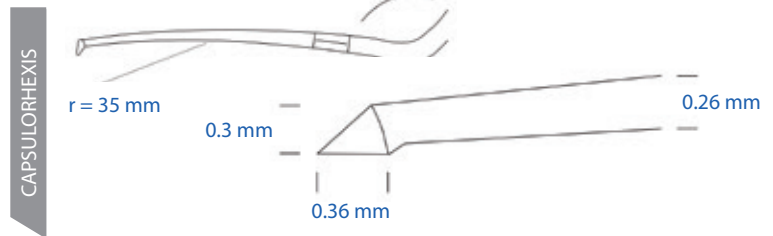

Capsulorhexis forceps round bodied - SC34

Length: 10.5 cm
 Handle length: 77 mm
 45° angled platform with tips 0.3 mm

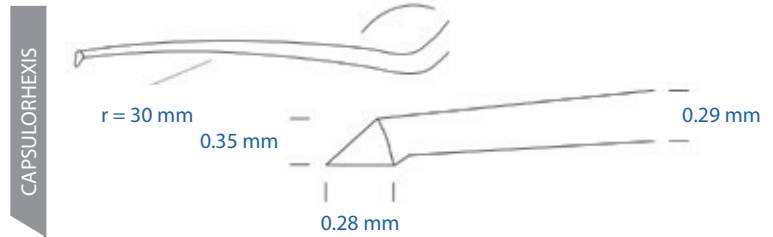

Capsulorhexis forceps straight - SC30

Length: 80 mm
 Handle length: 56 mm
 50° angled platform tips 0.5 mm

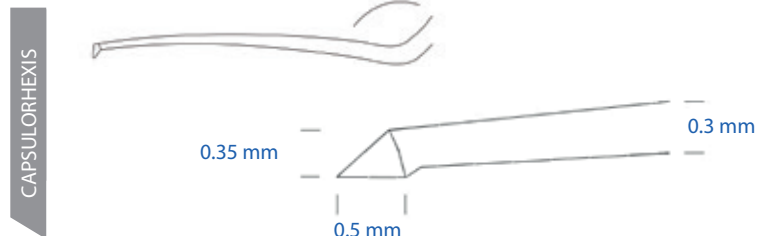

Capsulorhexis forceps straight • SC31

Length: 10.5 cm
 Handle length: 75 mm
 45° angled
 12 mm platform tips 0.3 mm

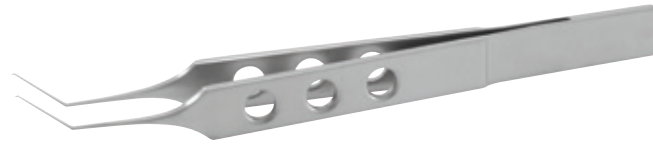

CAPSULORHEXIS

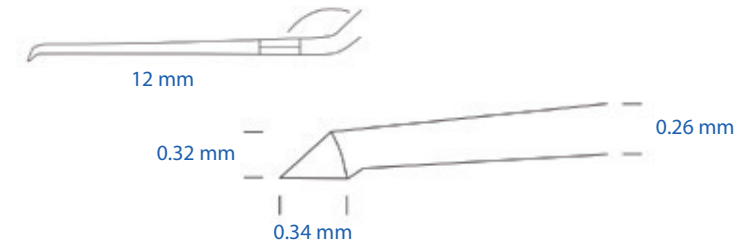
**MICS Capsulorhexis forceps cross action** • SC33M

Length: 11.5 cm
 Handle length: 84 mm
 50° angled
 2.2 mm incision



CAPSULORHEXIS

**Capsulorhexis forceps curved** • SC29

Length: 10.5 cm
 Handle length: 76 mm
 45° angled platform tips 0.3 mm 2.4 mm
 incision



CAPSULORHEXIS

**MICS Capsulorhexis forceps curved** • SC29M

Length: 10.5 cm
 Handle length: 77 cm
 45° angle
 12 mm platform
 0.3 mm tips
 2.2 mm incision



CAPSULORHEXIS



MICS Capsulorhexis forceps round bodied curved • SC34M

Length: 10.5 cm
 Handle length: 77 mm
 50° angle 0.2 mm tip
 12 mm platform
 2.2 mm incision



CAPSULORHEXIS

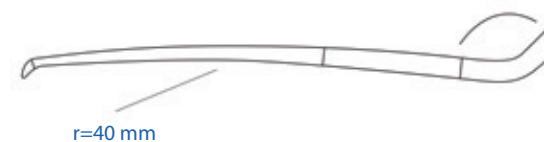

MICS Capsulorhexis forceps straight • SCM01

Length: 10.5 cm
 Handle length: 76 mm
 45° angled 0.3 mm tips, with 11 mm platform 2.2 mm incision



CAPSULORHEXIS



MICS Capsulorhexis forceps straight tipped • SC133M

Length: 10.5 cm
 Handle length: 76 mm



CAPSULORHEXIS



MICS Capsulorhexis forceps round bodied straight tipped • SC134M

Length: 10.6 cm
 Handle length: 76 mm



CAPSULORHEXIS



Adsons dissection forceps - SC59

Length: 12.5 cm
 Handle length: 97 mm
 1 into 2 teeth
 28 mm platform

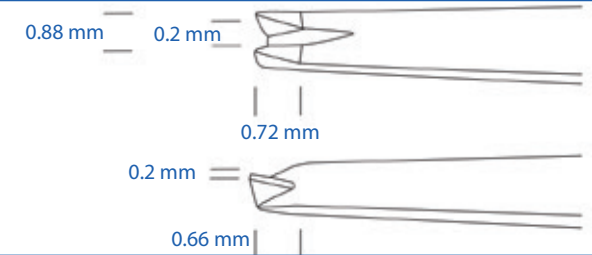

FIXATION

**Bishops forceps - SC56**

Length: 10.5 cm
 Handle length: 75 mm
 1 into 2 teeth
 5 mm platform

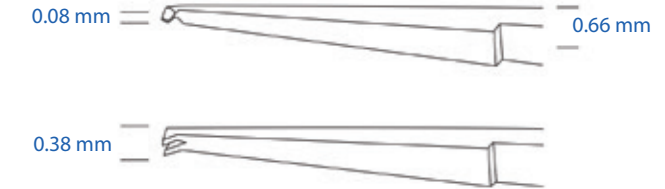

FIXATION

**Bonn forceps - SC38**

Length: 85 mm
 Handle length: 57 mm
 1 into 2 teeth 5 mm platform
 Short handle
 5 mm platform

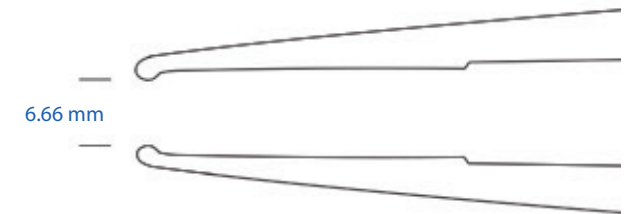

FIXATION

**Bonn forceps - SC129**

Length: 10.5 mm
 Handle length: 76 mm
 1 into 2 teeth 5 mm platform

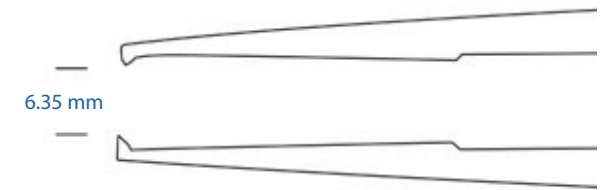

FIXATION

**Colibri toothed forceps - SC22**

Length: 11 cm
 Handle length: 72 mm
 55° angled
 1 into 2 teeth
 4 mm platform



FIXATION



Colibri tying forceps - SC20

Length: 85 mm
 Handle length: 59 mm
 55° angle forked tip
 Short handle
 4 mm platform



FIXATION

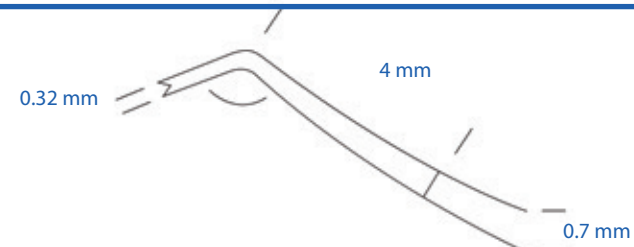

Fine claw forceps - SC115

Length: 10 cm
 Handle length: 68 mm
 2 into 1 teeth
 32 mm platform to tip



FIXATION

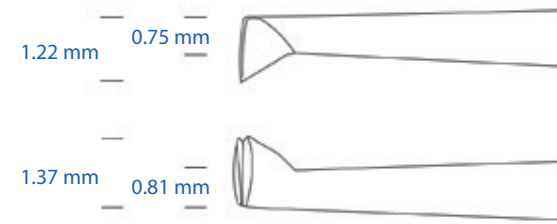

Hoskins forceps - SC55

Length: 85 mm
 Handle length: 56 mm
 Notched forceps
 5 mm platform



FIXATION



Iris forceps - SC116

Length: 10.5 cm
 Handle length: 67 mm
 1 into 2 teeth 5 mm platform



FIXATION



Iris forceps pointed - SC128

Length: 11 cm
 Handle length: 69 mm
 Serrated 15 mm platform



FIXATION



Jayles forceps • SC117

Length: 10.5 cm
 Handle length: 67 mm
 1 into 2 teeth 5 mm platform

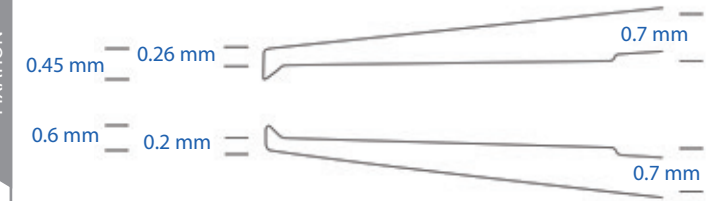

FIXATION

**Straight notched forceps** • SC49

Length: 11 cm
 Handle length: 76 mm
 Notched forceps
 5 mm platform

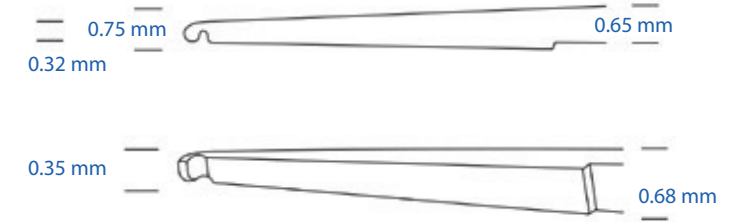

FIXATION

**St. Martins forceps** • SC54

Length: 84 mm
 Handle length: 56 mm
 1 into 2 teeth
 6 mm platform

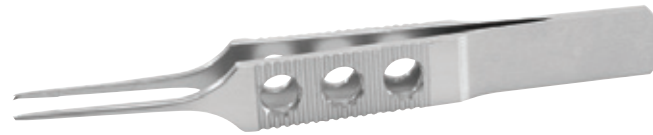

FIXATION

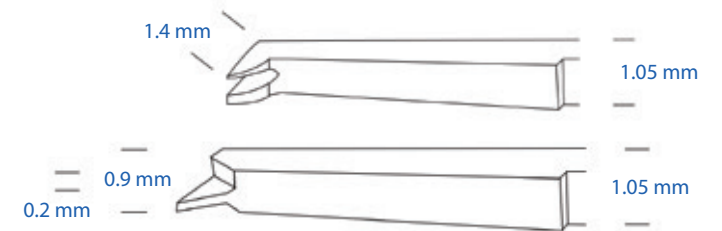
**Straight toothed forceps fine** • SC27

Length: 10.5 cm
 Handle length: 78 mm
 1 into 2 teeth 5 mm platform



FIXATION

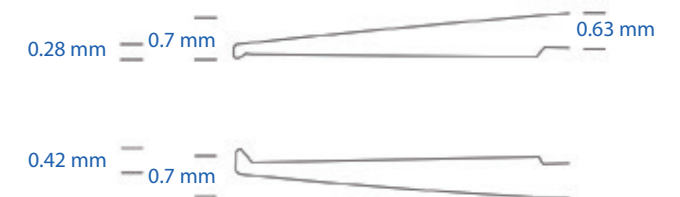

Adsons forceps • SC119

Length: 12.5 mm
Handle length: 97 mm
14 mm serrated platform

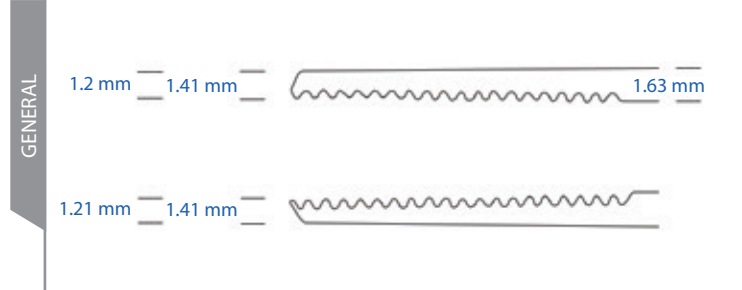

Adsons forceps fine serrated • SC113

Length: 12.5 cm
Handle length: 88 mm
serrated 14 mm tying platform

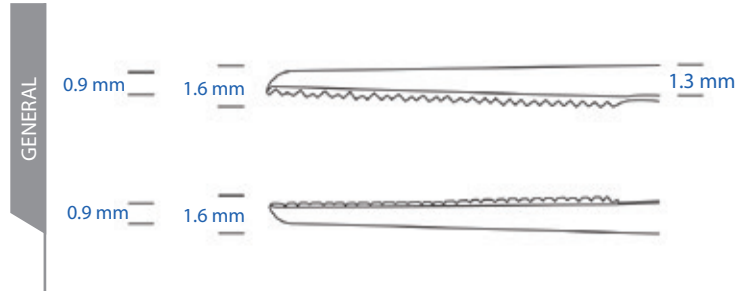

Denis sclerectomy forceps • SC104

Length: 10.5 cm
Handle length: 75 mm
30 mm platforms

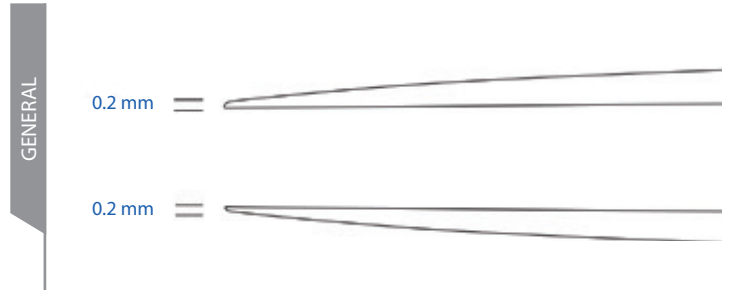

Epilation - Cilia forceps • SC58

Length: 73 mm
Platform 50 mm

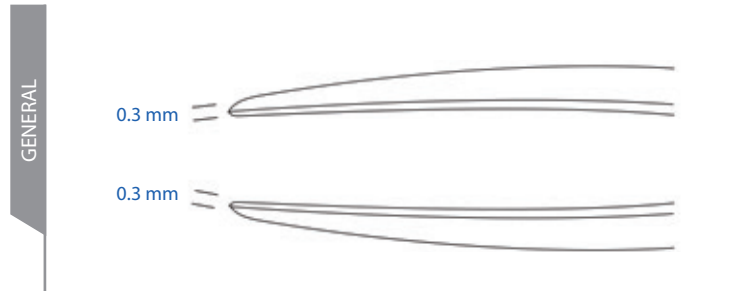

Epilation forceps - SC127

Length: 88 mm
18 mm platform

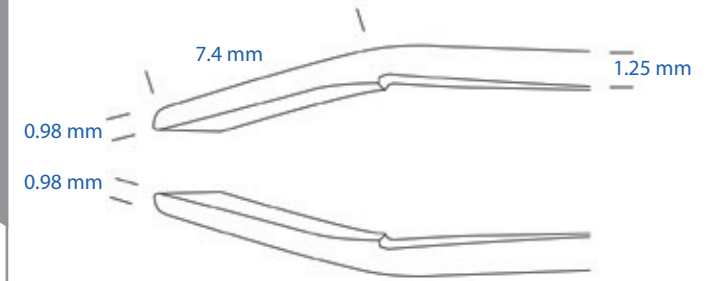

GENERAL

**Jewellers forceps** - SC60

Length: 11.5 cm
Handle length: 82 mm
0.1 mm fine pointed ends
32 mm platform

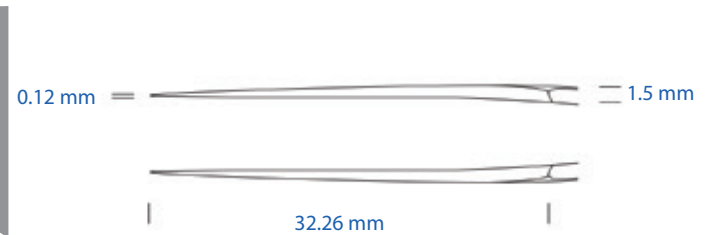

GENERAL

**Moorfields forceps** - SA12

Length: 11 cm
Handle length: 68 mm
Serrated 15 mm platform

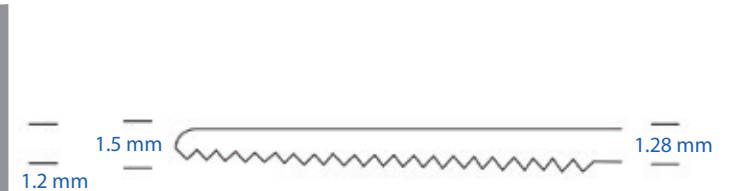

GENERAL

**Moorfields fine forceps** - SA17

Length: 11 cm
Handle length: 71 mm
Serrated 15 mm platform



GENERAL

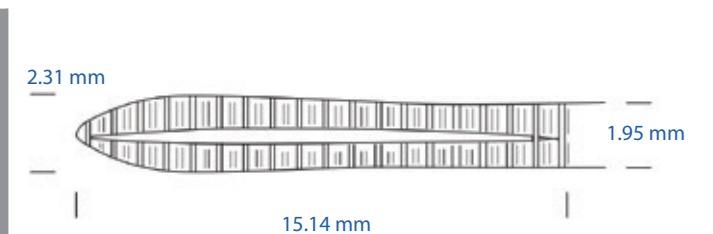

Mosquito forceps - SG02

Length: 13 cm
22 mm serrated clamp area

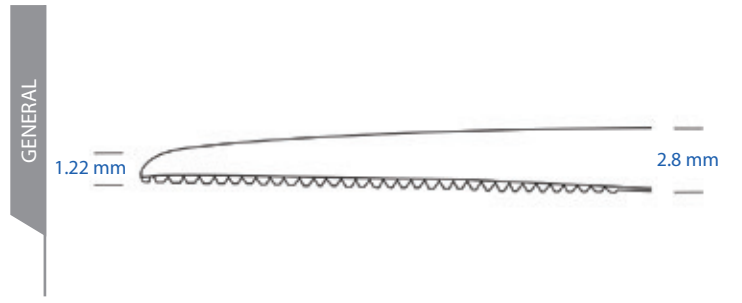

IOL removal forceps - SC112

Length: 82 mm
Handle length: 54 mm
35° angled serrated tips, with 13 mm platform

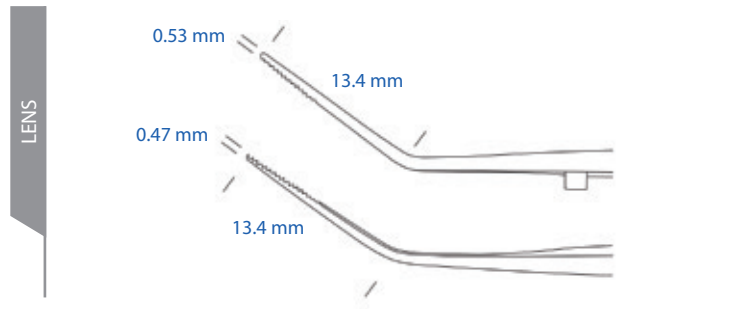

Lens folding forceps - SC51

Length: 10.5 cm
Handle length: 78 mm
45° angled, 1 cm platform

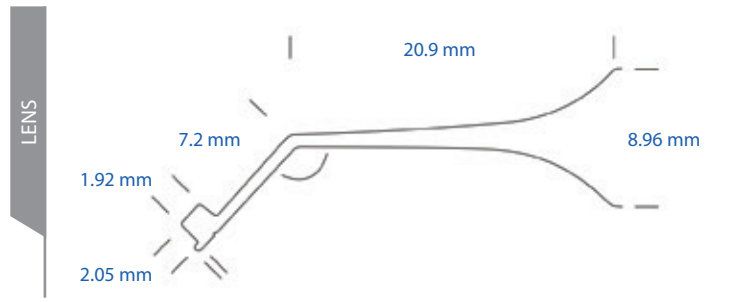

Lens implantation forceps - SC52

Length: 10.5 cm
Handle length: 76 mm
40° angled platform
10 mm platform

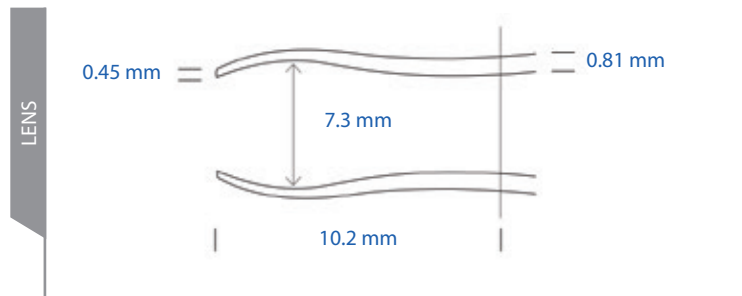

Curved notched forceps • SC50

Length: 10 cm
 Handle length: 76 mm
 Curved 5 mm tying platforms

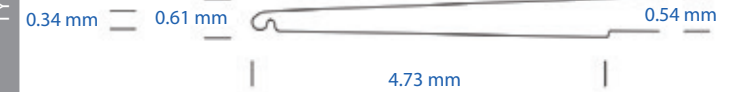

TYING

**Kelman Mc Pherson forceps • SC73**

Length: 83 mm
 Handle length: 57 mm
 50° angled 7 mm tying platforms



TYING

**Mc Pherson tying forceps • SC72**

Length: 10.5 cm
 Handle length: 76 mm
 45° angled 5 mm tying platforms

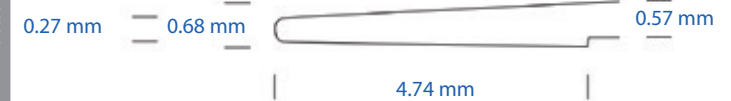

TYING

**Straight tying forceps • SC19**

Length: 85 mm
 Handle length: 56 mm
 5 mm tying platforms



TYING

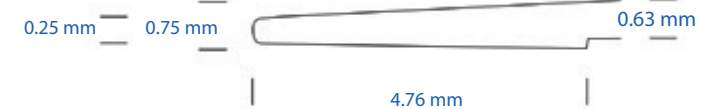

Straight tying forceps - SC71

5 mm platforms
 Length: 10.5 cm
 Handle length: 75 mm
 5 mm tying platform

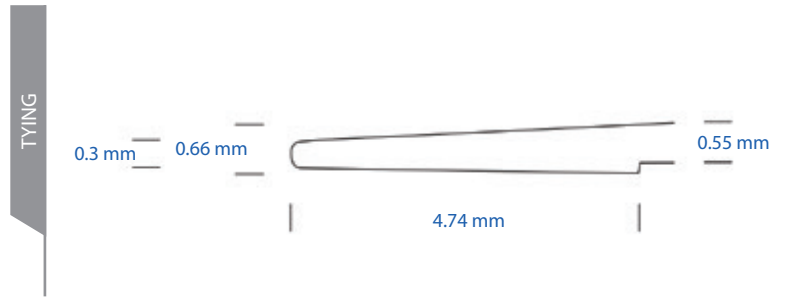

Suture removal forceps curved - SC120

Length: 10.5 cm
 Handle length: 76 mm
 Pointed tips, 5 mm tying platform

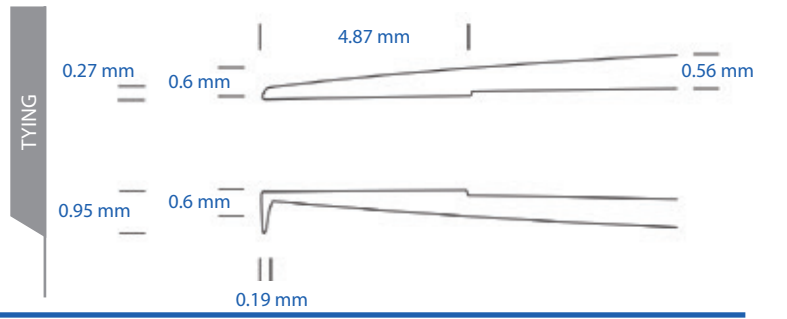

Troutman tying forceps curved - SC105

Length: 10.5 cm
 Handle length: 76 mm
 5 mm tying platform

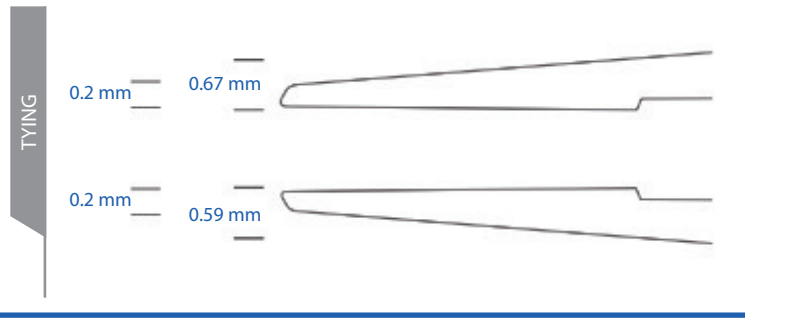

Manipulators and Choppers



Single Use Instrument Code

Chopper and dialler - SC39

Length: 12 cm
 Handle length: 76 mm
 45° angled ends, one rounded tip and one 1 mm Y shaped end
 Round bodied
 Double ended

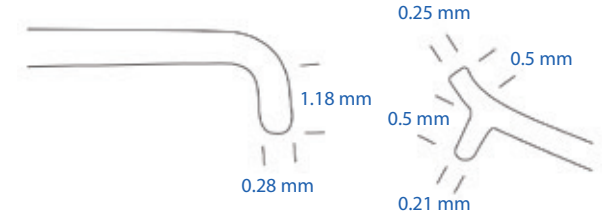

Chopper and kuglen horizontal double ended - SC95

Length: 12.7 cm
 Handle length: 70 mm
 40° angled paddle shaped tip
 Round bodied

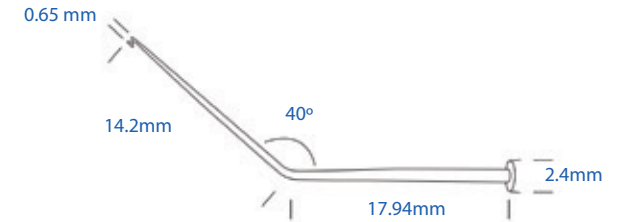

Denis cleaver - SC97

Length: 11 cm
 Handle length: 90 mm

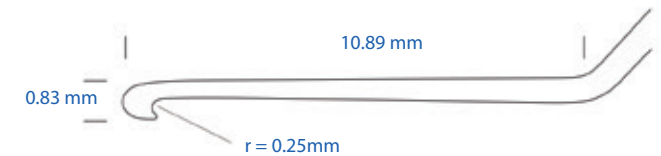

Drysdale micro manipulator - SC89

Length: 12 cm
 Handle length: 90 mm
 Round bodied

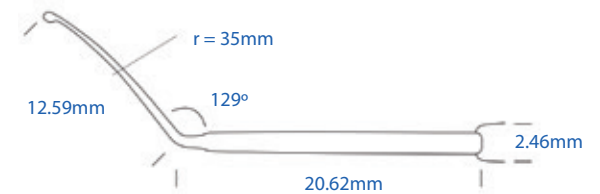

Drysdale nucleus spatula - SC47

Length: 11 cm
 Handle length: 85 mm
 45° angled paddle shaped tip
 Round bodied



Govan manipulator - SC100

60° angle pointed tip
Round bodied

**Govan manipulator and Phaco chopper - SC102**

Length: 12 cm
Handle length: 78 mm
60° pointed end and 90° blunt end
Round bodied
Double ended

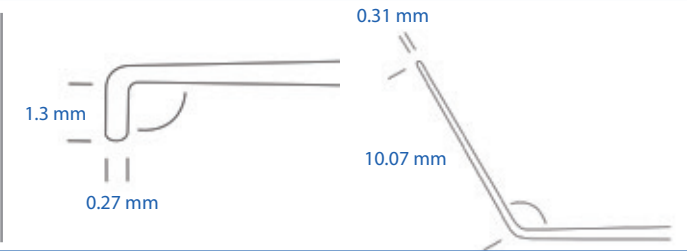
**Greens chopper - SC45**

Length: 11.5 cm
Handle length: 95 mm
30° angled top curved rounded hook
Round bodied

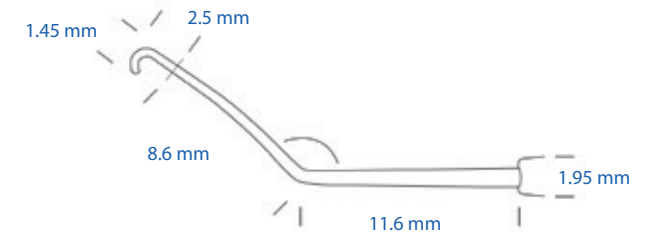
**Iris repositor - SC63**

Length: 13 cm
Handle length: 98 mm

**Jones chopper - SC90**

Length: 12 cm
Handle length: 95 mm
45° angled pointed tip
Round bodied



Koch chopper - SC44

Length: 12 cm
 Handle length: 95 mm
 45° angled 1 mm rounded tip
 Round bodied

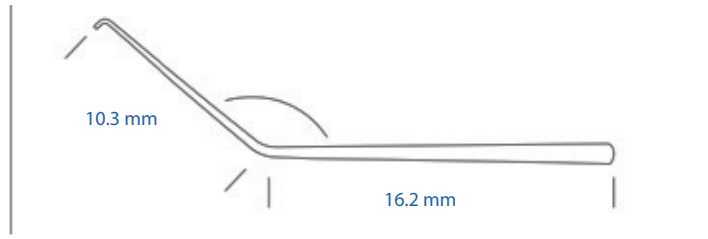

Koch phaco spatula - SC143

Length: 12 cm
 Handle length: 96 mm
 Slight curved spatula
 Round bodied

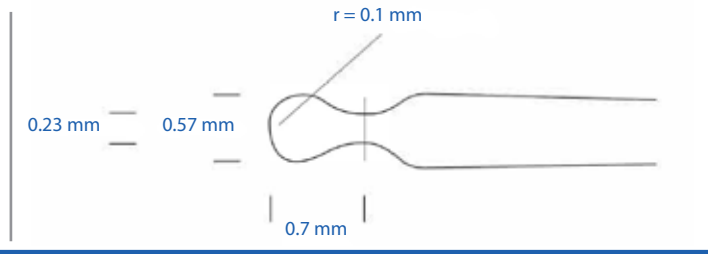

Kuglen hook - SG15

Length: 11.5 cm
 Handle length: 95 mm
 45° angled blunt, flat hooked tip
 Round bodied

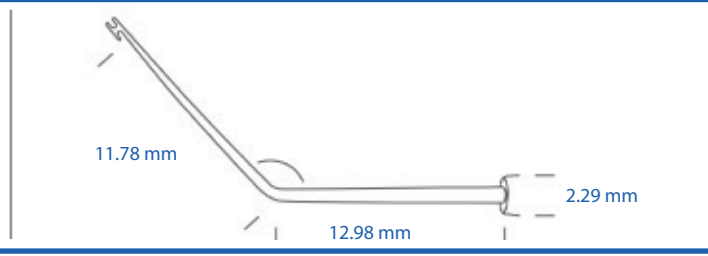

Le Buisson manipulator - SC106

Length: 11.5 cm
 Handle length: 90 mm
 Round bodied

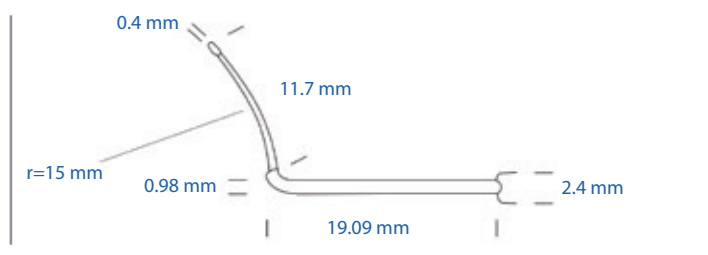

Lens dialer - SC46

Length: 12 cm
 Handle length: 95 mm
 35° angled
 Round bodied

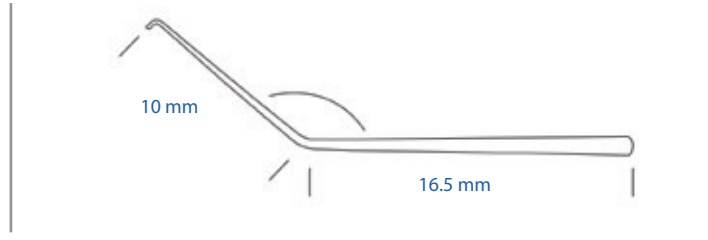

Lester hook • SC146

Length: 11.5 cm
 Handle length: 10 cm
 Round bodied

**Mushroom nucleus manipulator** • SC48

Length: 12 cm
 Handle length: 95 mm
 45° angled mushroom shaped tip
 Round bodied

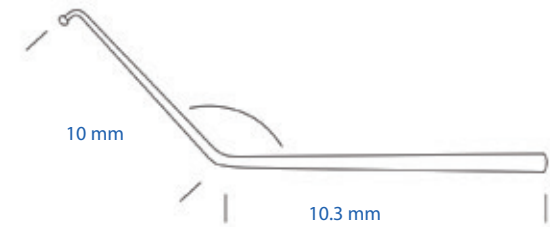
**Phaco chopper and Mushroom manipulator double ended** • SC147

Length: 12 cm
 Handle length: 70 mm
 45° chopper
 Round bodied
 Double ended

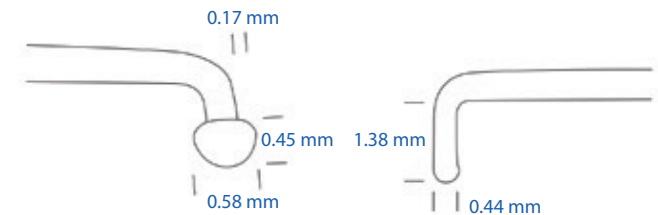
**Phaco chopper** • SC43

Length: 12 cm
 Handle length: 95 mm
 40° angled round end
 Round bodied

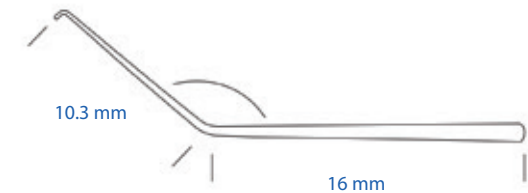

Phaco chopper claw - SC42

Length: 12 cm
Handle length: 95 mm
40° angled tip, hooked tip
Round bodied



Pisacano rotator and Neuham manipulator double end - SC101

Length: 10 cm
Handle length: 75 mm
60° spatula end and 30° round end
Round bodied
Double ended



Sinskey hook and Govan manipulator double ended - SC144

Length: 12 cm
Handle length: 76 mm
60° manipulator and 45° hooked end
Round bodied
Double ended

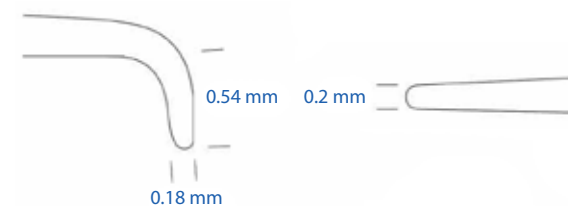

Y shaped Nucleus rotator - SC41

Length: 12 cm
Handle length: 95 mm
40° angled tip Y shaped end
Round bodied

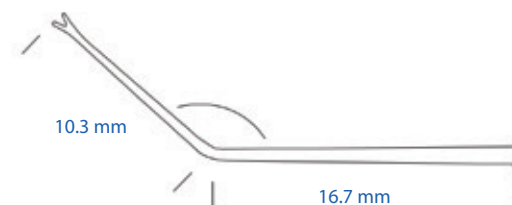

Speculums

Wire | Mechanical | Paediatric



Single Use Instrument Code

Broad gauge wire speculum - SC01

Length: 50 mm
Width: 40 mm



WIRE

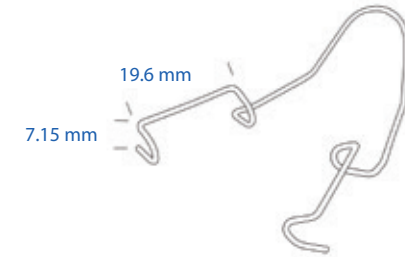

Heavy gauge wire speculum open loop - SC124

Length: 72 mm
Overall width: 58 mm

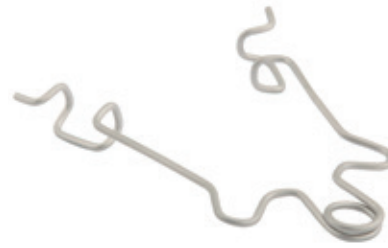

WIRE

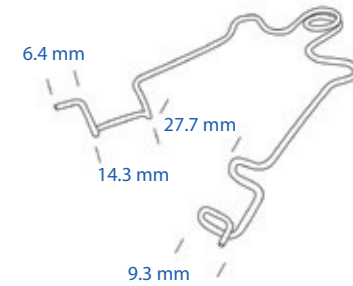

Kratz Barraquer closed loop - SC09

Length: 40 mm
Width: 42 mm



WIRE



Kratz Barraquer closed loop speculum - SC132

Length: 43 mm
50° angle at base



WIRE

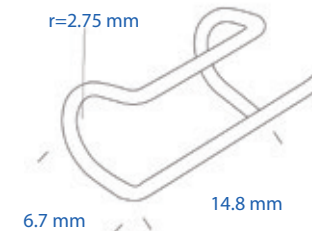

Kratz Barraquer open loop wire speculum - SC11

Length: 47 mm
 Width: 31 mm
 50° angle at base

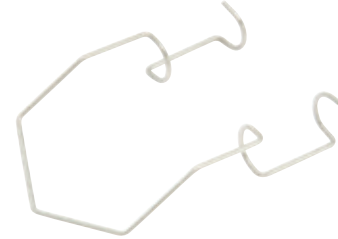

WIRE

**Kratz open loop wire speculum (blue) - SC107**

Length: 44 mm
 Overall width: 30 mm
 50° angle at base

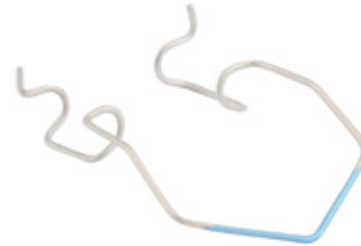

WIRE

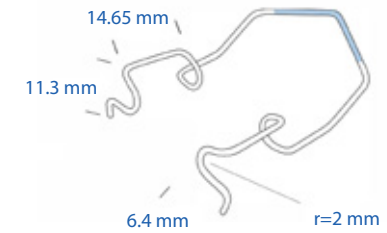
**Kratz solid bladed wire speculum - SC05**

WIRE

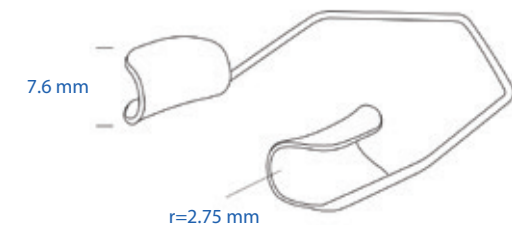
**Kratz closed loop speculum - SC13**

Length: 32 mm
 50° angle at base

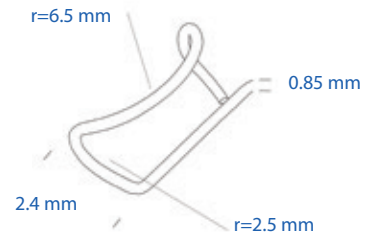

WIRE

**Open loop wire speculum - SC150**

Length: 38 mm
 Width: 38 mm



WIRE

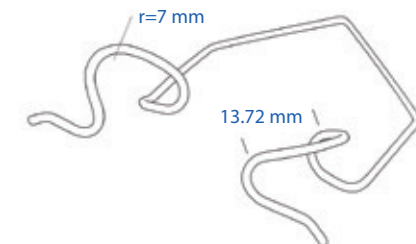

Speculum open loop • SC155

Length: 45 mm
Overall width: 30 mm



WIRE

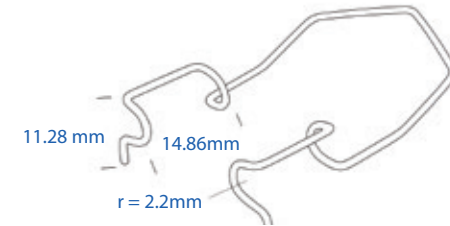

Temporal speculum • SC12

Length: 50 mm
Width: 42 mm



WIRE



Wide angled closed loop speculum • SC07

Length: 44 mm
Width: 42 mm



WIRE

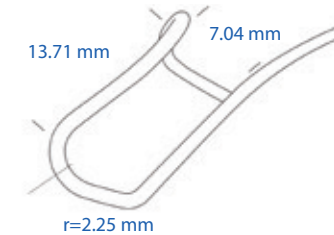

Bangerter adult speculum • SC03

Length: 50 mm
sliding screw adjustable
Blade length: 15 mm



WIRE

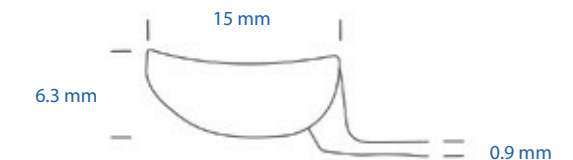

Bladed adjustable speculum - SR10

Length: 75 mm
Blade length: 15 mm

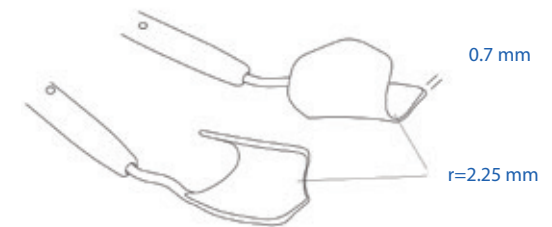

MECHANICAL

**Clarke speculum - SC126**

Length: 80 mm
Open loop: 12 mm

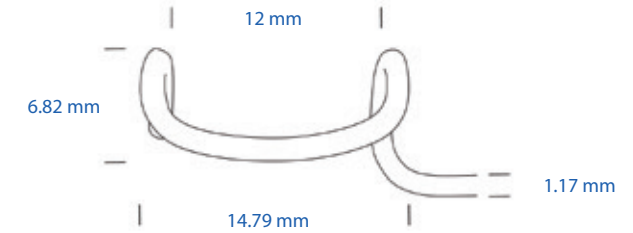

MECHANICAL

**Kratz screw adjustable wire speculum open loop - SR11**

Length: 78 mm
Blade length 15 mm

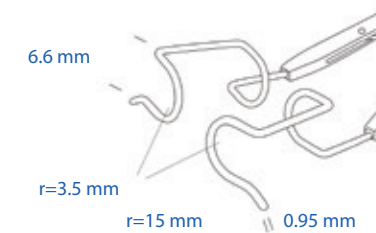

MECHANICAL

**Lieberman speculum stainless steel - SC121**

Length: 80 mm
Blade length 14 mm

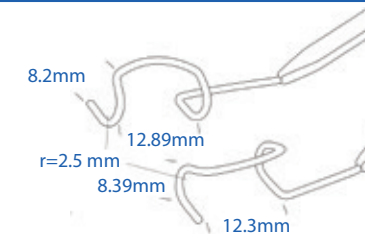

MECHANICAL

**Solid bladed screw adjustable speculum - SC08**

Length: 85 mm
Blade length: 14 mm



MECHANICAL

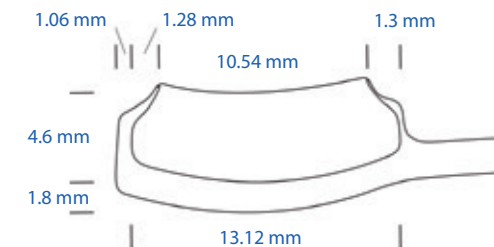

Kratz paediatric closed loop 10 mm speculum - SC10

Length: 29 mm
Width: 30 mm
10 mm



PAEDIATRIC

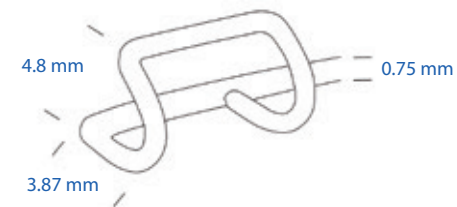

Neonate paediatric speculum - SC103

Length: 25 mm
Width: 20 mm
4 mm closed loop
80° angle at base



PAEDIATRIC



Neonate 4 mm speculum - SC15

Length: 25 mm
Width: 31 mm
20-30 mm adjustable
3 mm blade



PAEDIATRIC

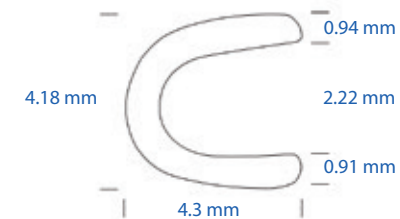

Paediatric 6 mm speculum - SC14

Length: 25 mm
Width: 35 mm
6 mm blade



PAEDIATRIC

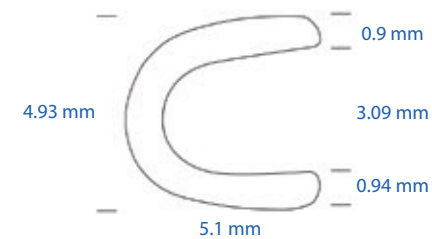

Scissors

Spring Handled | General



Single Use Instrument Code

Castroviejo corneal scissor right and left • SC82

Length: 10 cm
Handle length: 75 mm

- SC83 Castroviejo corneal scissor left
8 mm blade



SPRING HANDLED

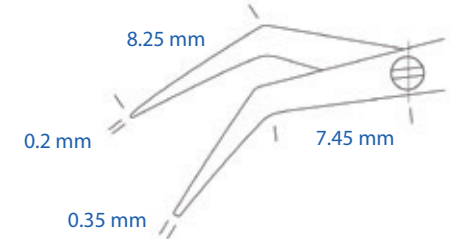

Castroviejo scissors curved and blunt • SC110

Length: 11 cm
Handle: 65 cm
11 mm blade



SPRING HANDLED

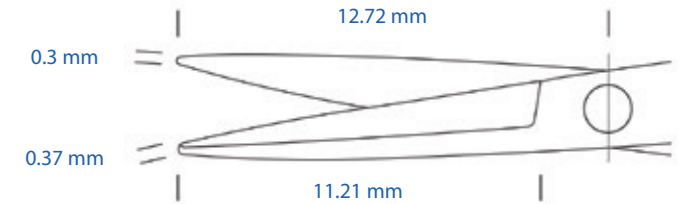

Castroviejo scissors straight • SC111

Length: 10 cm
Handle length: 63 mm
Straight tipped
60 mm blade



SPRING HANDLED

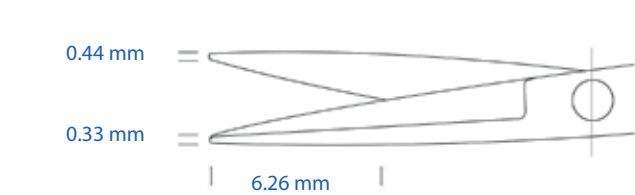

Ong iris scissor • SC80

Length: 88 mm
Handle: 52 mm
10 mm blade



SPRING HANDLED

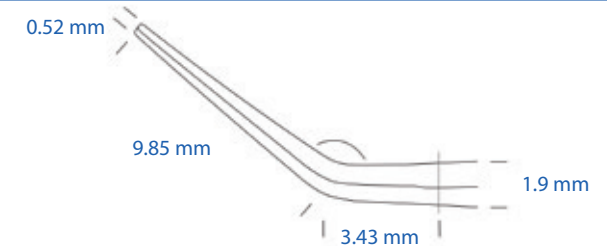

Osher scissors • SC109

Length: 95 mm
Handle length: 61 mm
Fine serrated cutting platform
9 mm blade



SPRING HANDLED

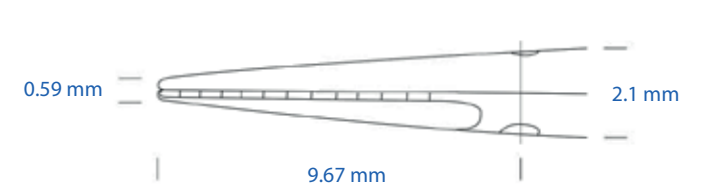

Stallard corneal scissors • SA13

Length: 12 cm
 Handle length: 67 mm
 Fine pointed ends
 40 mm blade

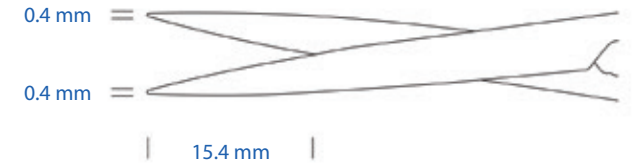

SPRING HANDLED

**Vannas scissors** • SC81

Length: 83 mm
 Handle length: 52 mm
 8 mm blade

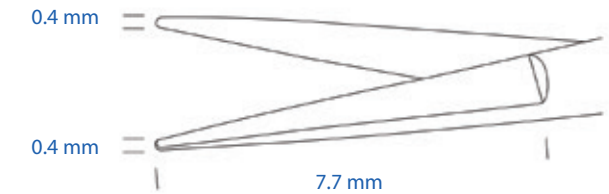

SPRING HANDLED

**Vannas scissors curved** • SC108

Length: 10 cm
 Handle length: 62 mm
 Sharp pointed end
 9 mm blade

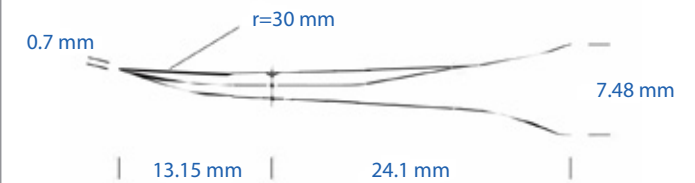

SPRING HANDLED

**Westcott conjunctival scissors** • SA11

Length: 11.5 cm
 Handle length: 79 mm
 12 mm blade



SPRING HANDLED



Wescott scissors dolphin nose • SA14

Length: 11.5 cm
Handle length: 67 mm
10 mm blade



SPRING HANDLED

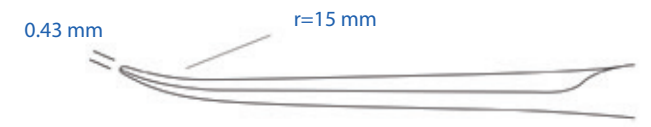

Westcott dolphin nose scissors blunt tipped • SA15

Length: 11.6 cm
Handle length: 72 mm



SPRING HANDLED

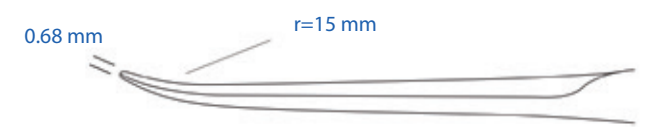

Dressing scissors • SG35

Length: 11.5 cm
Handle length: 26 mm
30 mm blade



GENERAL



Enucleation scissors • SG34

Length: 25 mm
6 mm blade



GENERAL



General long handle scissors blunt end • SG14

Length: 13 cm
Blunt round end
40 mm blade



GENERAL

**General scissors blunt end • SG06**

Length: 89 mm
Blunt end
24 mm blade

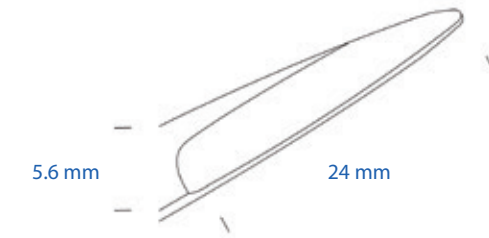

GENERAL

**General scissors sharp pointed • SG01**

Length: 88 mm
Sharp pointed end
22 mm blade

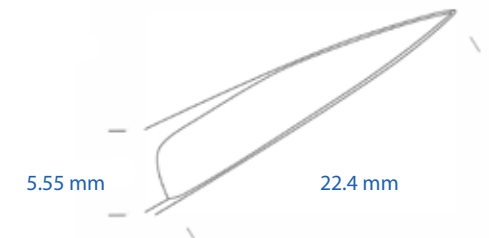

GENERAL

**Iris scissor • SC96**

Length: 11 cm
22 mm blade



GENERAL

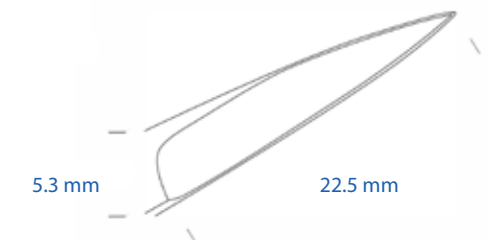

Metzenbaum scissors curved pointed - SG30

Length: 11 cm
35 mm blade



GENERAL

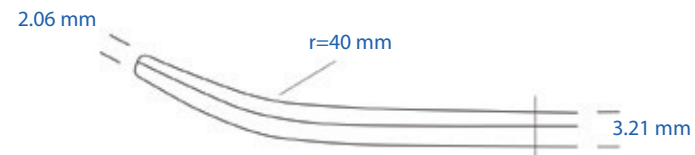

Strabismus scissors - SG07

Length: 11.5 cm
Blunt end
38 mm blade



GENERAL



Stevens scissors curved - SG23

Length: 11.5 cm
38 mm blade



GENERAL

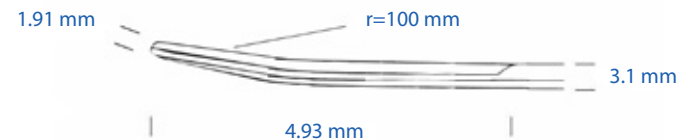

Stevens tenotomy scissors pointed - SG31

Length: 11.6 cm
Tip width: 1.9mm



GENERAL

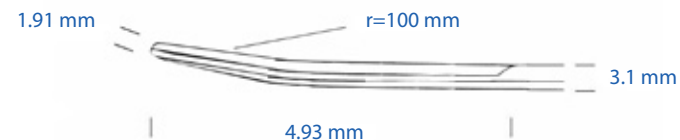

General ophthalmic



■ Single Use Instrument Code

Ball tip muscle hook • SG32

Length: 10.5 cm
Handle length: 76 mm

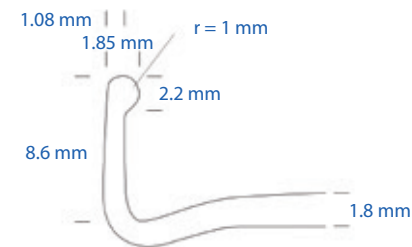

Bulldog clip • SG92

Length: 40 mm
Handle length: 25 mm
16 mm clipping platform not on website

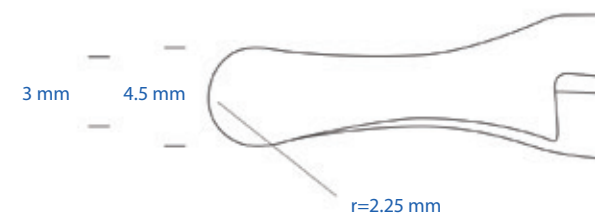

Chavasse hook • SC91

Length: 13 cm
Handle length: 98 mm
90° angle, curved hooked tip

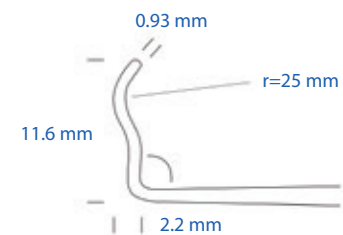

Desmarres retractor 18mm wide • SG20

Length: 14 cm
Handle length: 100 mm

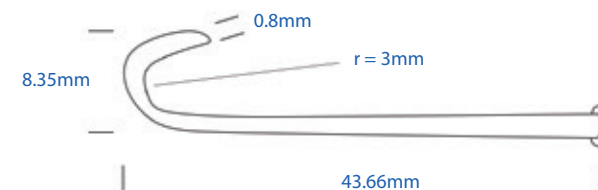

Eyelid plate • SG17

Length: 90 mm
27 mm end
17 mm end

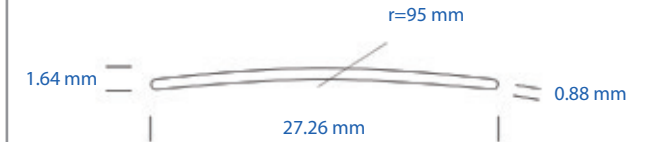
**Gillies hook small** • SG28

Length: 12 cm
Handle length: 90 mm

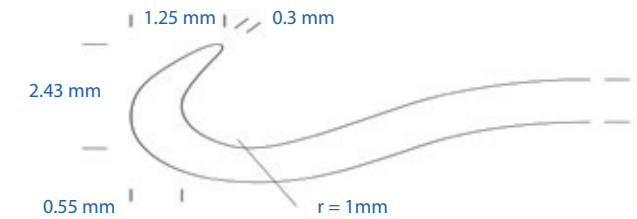
**Guthrie hook** • SG37

Length: 12 cm
Handle length: 90 mm
Two pronged hook

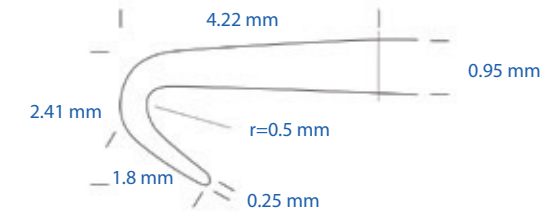
**Halstead mosquito forceps straight** • SG33

Length: 12.5 cm

**Jameson strabismus hook 5 mm** • SG10

Length: 11 cm
Handle length: 83 mm
60° hook with rounded bulbous tip
■ SG11 extended version 8 mm hook

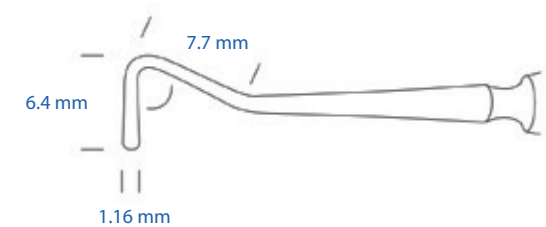

Mosquito forceps curved • SG22

Length: 12.5 cm
22 mm serrated clamp area

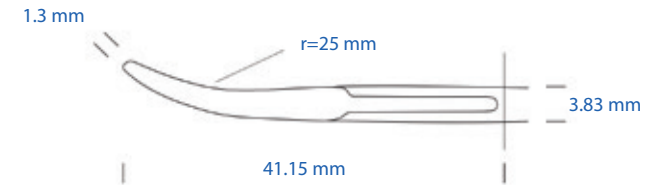

Muscle hook with hole • SG18

Length: 13.8 cm
Handle length: 95 mm



Scleral depressor bulbous end • SC23

Length: 13 cm
Handle length: 92 mm
2.5 mm 10° angled bulbous end



Scleral depressor double ended • SC25

Length: 13.5 cm
Handle length: 60 mm
6 mm, 2 mm hammer end,
2.5 mm 10° angled bulbous end
Double ended



Scleral depressor hammer shape • SC24

Length: 12.5 cm
Handle length: 92 mm
6 mm hammer, 2 mm ends

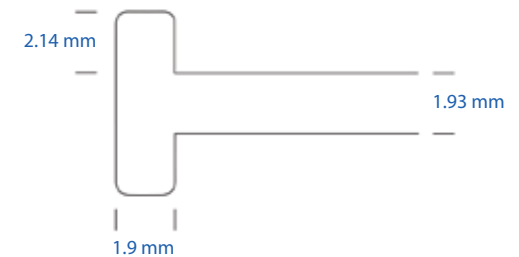

Thornton fixation ring small 13 mm • SG12

Length: 13 cm
 Handle length: 91 mm
 swivel head 11 mm cut out

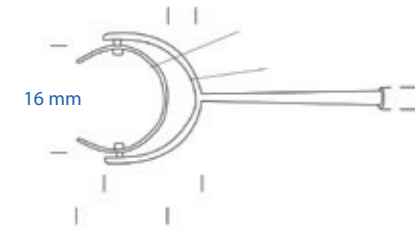
**Thornton fixation ring standard 16 mm • SG13**

Length: 13.5 cm
 Handle length: 91 mm
 swivel head 14 mm cut out

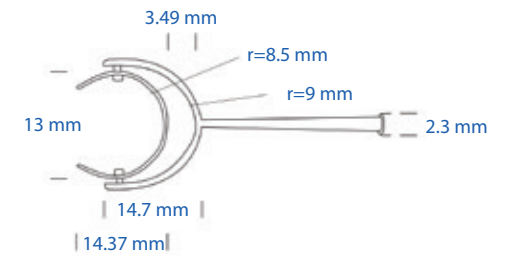
**Trabeculectomy punch • SG03**

Length: 12 cm
 Handle length: 90 mm

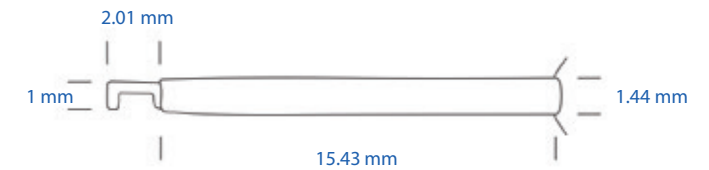
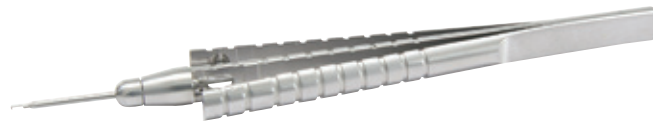

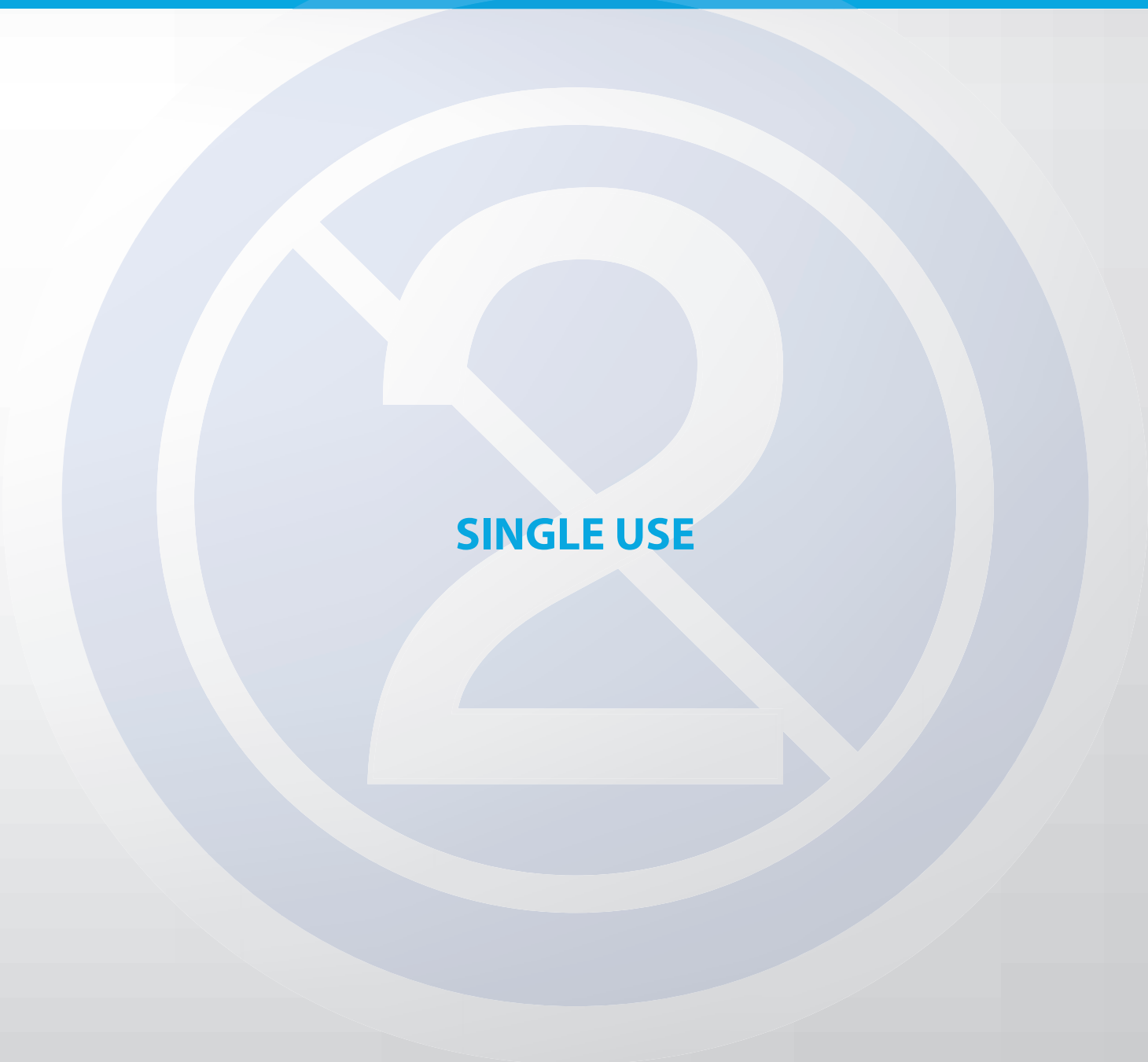

Corneal and Refractive

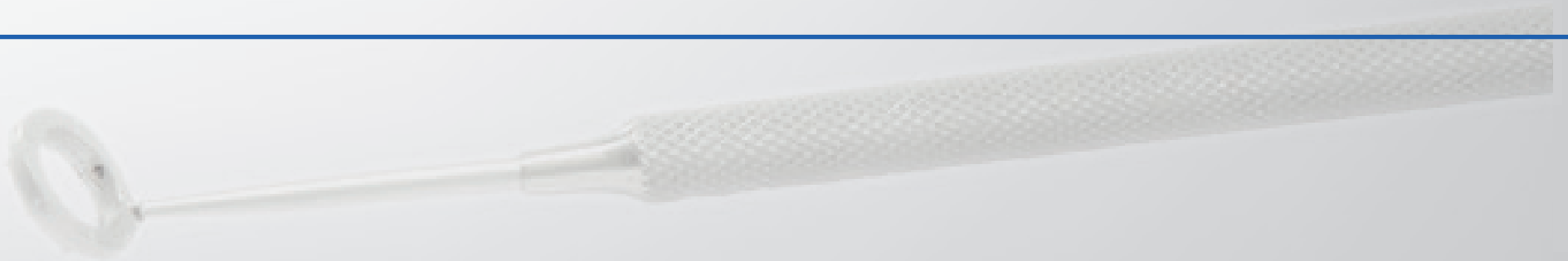

Single Use Instrument Code

Alcohol well various sizes • SR41

Length: 12.5 cm / Handle length: 92 mm
Liquid holding well for alcohol application / Round bodied

- SR41 9 mm
- SR42 8 mm
- SR43 7 mm

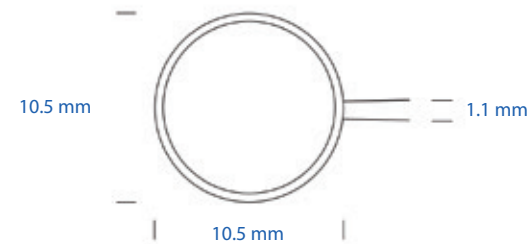
**Bernheim hook DSAEK** • SR109

Length: 12 cm
Handle length: 95 mm

**Bladed adjustable speculum** • SR10

Length: 46 mm
Blade length: 15 mm
Blade radius: 2.25mm

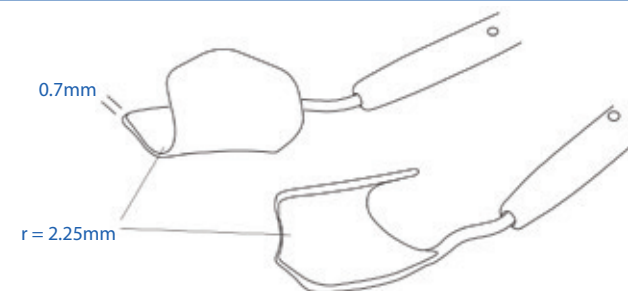
**Corneal epithelium spatula round** • SR100

Length: 11 cm
Handle length: 85 mm



Corneal marker 8 line • SR72

Length: 11 cm
Handle length: 82 mm

**CK Lasik marker** • SR40

Length: 10 cm
Handle length: 76 mm
facilitate marking of the cornea
Round bodied

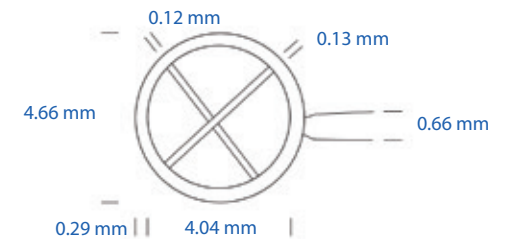
**Corneal ring pusher** • SR04

Length 11 cm
Handle length 91 mm

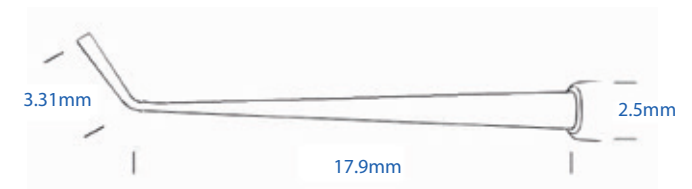
**Corneal ring pocketing hook** • SR05

Length 11 cm
Handle length 91 mm



Corneal ring pocket spreader - SR06

Length 10 cm
Handle length 90 mm

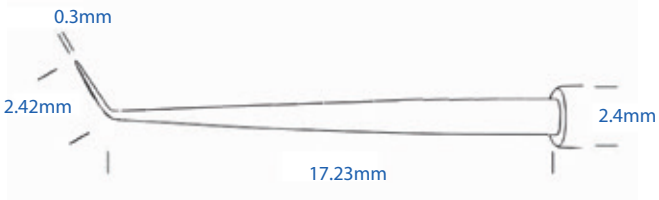

Corneal ring forceps Keraring - SR07

Length 10cm
Handle length 77 mm

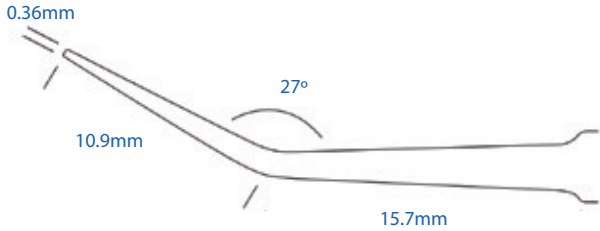

Corneal ring forceps INTACS - SR08

Length 8 cm
Handle length 53 mm

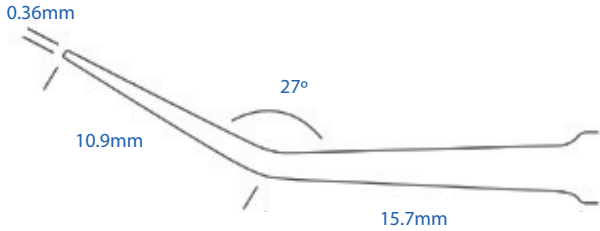

Epi peeler rectangle shaped - SR61

Length 11 cm
Handle length 95 mm

**Epi peeler D shaped - SR60**

Length 11 cm
Handle length 95 mm

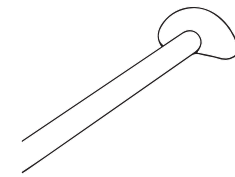
**Epi peeler - SR51**

Length: 11 cm
Handle length: 95 mm
Manipulate epithelium during surgery

**Implantation forceps - SR91**

Length: 117 mm
Handle length: 70 mm

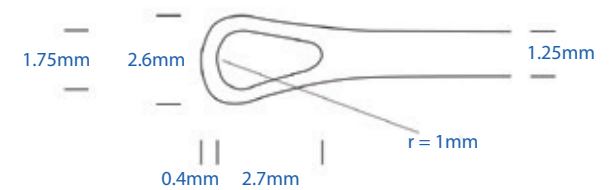
**Intra Lasik flap separator - SR34**

Length: 12 cm
Round bodied

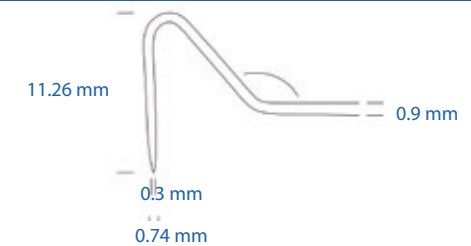

Kocaba DMEK forceps - SR102

Length: 86 mm
Handle length: 56 mm

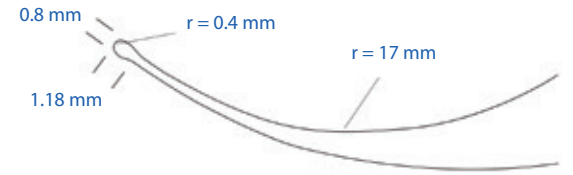

Kratz screw adjustable open loop speculum - SR11

Length: 78 mm
Blade length: 15 mm

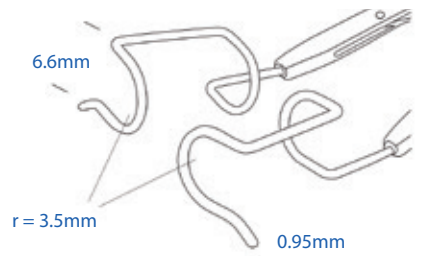

Lasik corneal marker - SR21

Length: 12 cm
Handle length: 91 mm
Y shaped forked marker

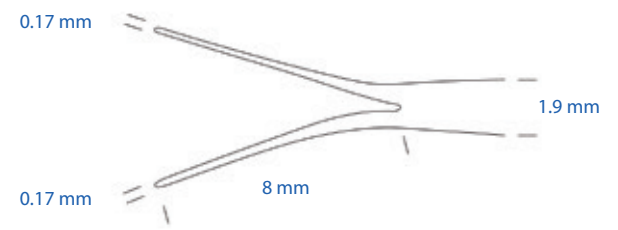

Lasik femto separator and elevator double ended - SR02

Length: 115 mm
Handle length: 70 mm

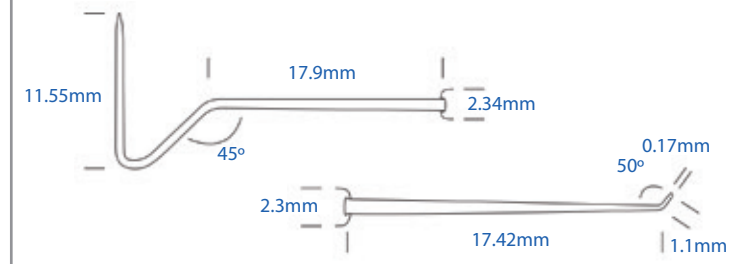

Lasik flap elevator - SR31

Length: 12 cm
 Handle length: 95 mm
 45° angled, 12 mm tip with 0.1 mm rounded end

**Lasik flap forceps - SR14**

Length: 10 cm
 Handle length: 76 mm

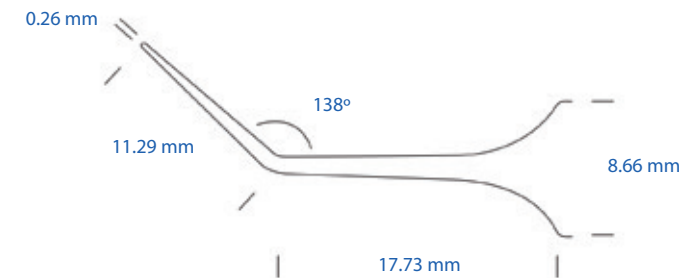
**Lasik flap forceps - SR71**

Length: 10 cm
 Handle length: 77 mm
 40° angled platform, circular 1 mm tips

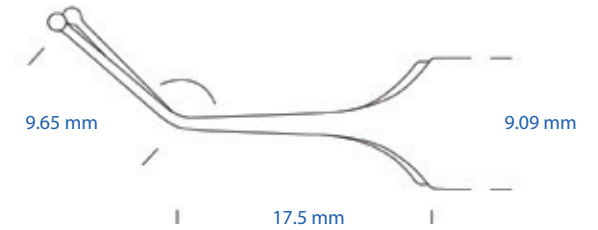
**Lasik flap seperator and elevator double end - SR103**

Length: 12 cm
 Handle length: 70 mm
 45° and 650° ends
 Double ended

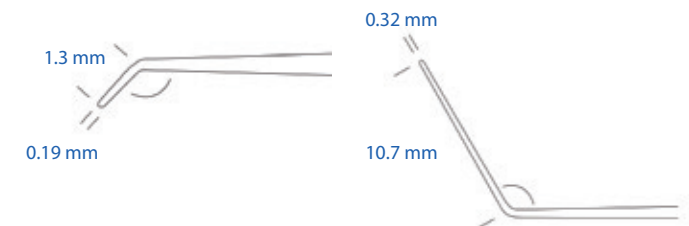

Lenticule extraction forceps • SR01

Length: 115 mm
Handle length: 81 mm

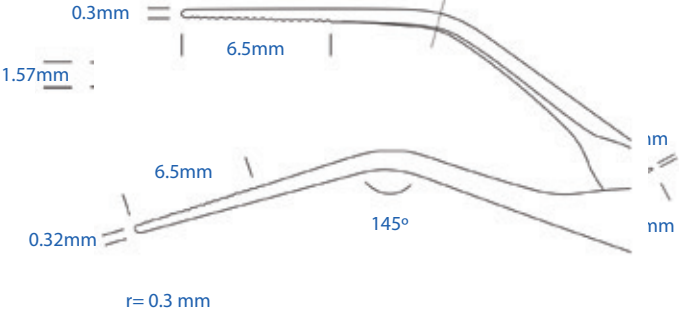

Paton spatula and spoon double ended • SR108

Length: 151 mm
Handle length: 71 mm



Reinstein Lenticule separator elevator double ended • SR104

Length 11 cm
Double ended
Handle length 70 mm

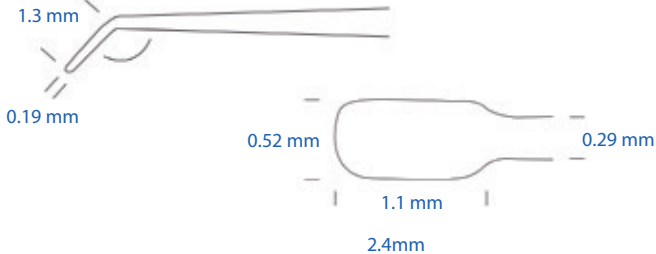

Reinstein Lenticule separator • SR70

Length: 110 mm
Handle length: 90 mm

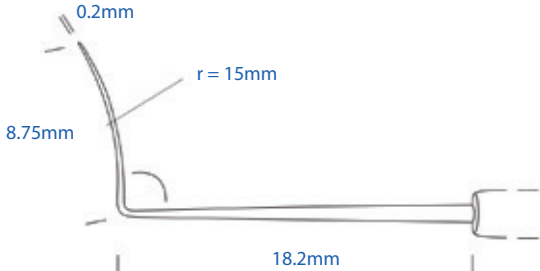

S Marker - SR101

Length: 11 cm
 Handle length: 90 mm
 45° angle 2 mm marking end

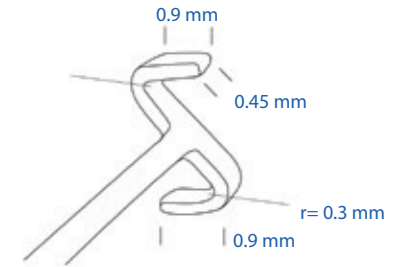
**Sinskey and reverse Sinskey hook** - SR03

Length 12 cm
 Handle length 70 mm

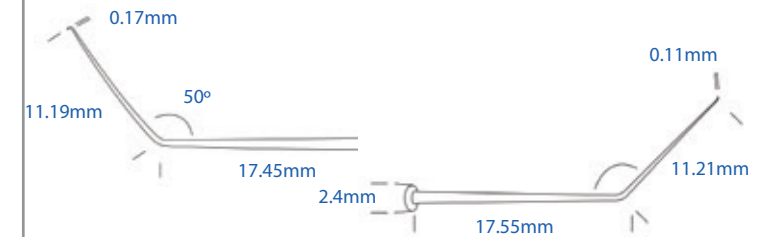
**Trephine various sizes** - SR105

- SR110 16 mm
- SR105 17 mm
- SR106 18 mm
- SR107 19 mm

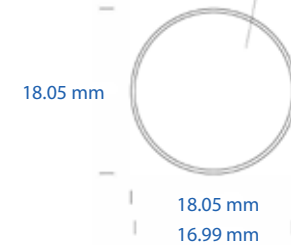

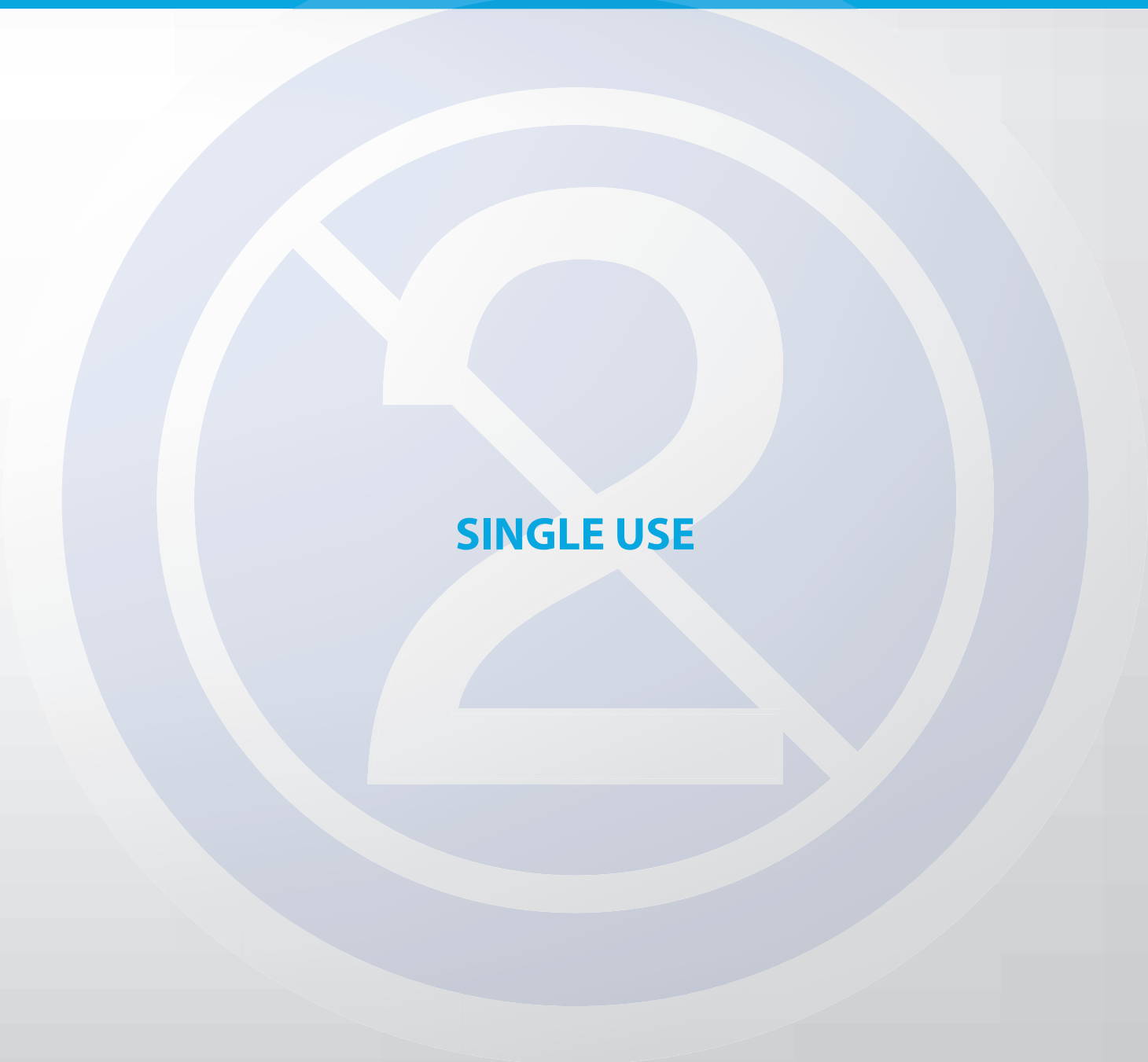

Measurers and Markers



■ Single Use Instrument Code

Braunstein fixed caliper 1.8 mm thickness - SG04

Length: 68 mm
 3.5 mm 4 mm measure
 (Available in other thicknesses of metal, please contact us for details)

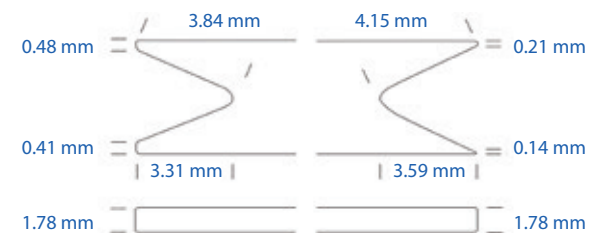

Castroviejo adjustable caliper - SG05

Length: 85 mm
 20 mm measure

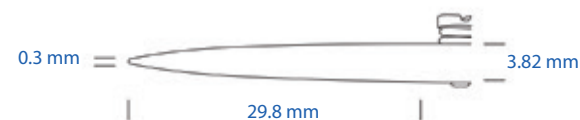

Corneal marker capsulorhexis guide - SC130

Length: 12 cm
 Handle length: 92 mm
 6 mm well
 Round bodied



Heleveston ruler - SG93

Length: 11.7 cm
Handle length: 89 mm

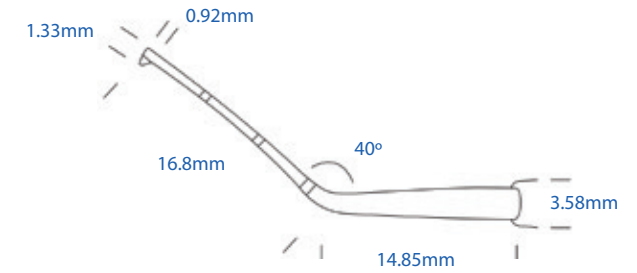
**Mendez Gauge** - SC65

Length: 12 cm
Handle length: 80 mm
180° circular marker

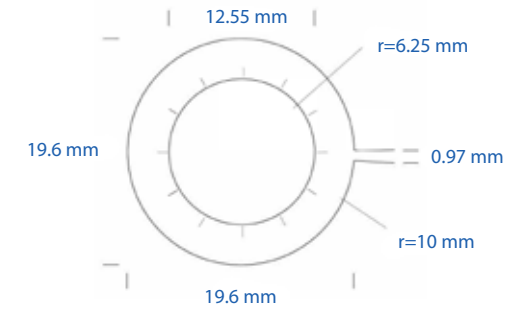
**Scleral marker round bodied double ended** - SG19

4.5 and 3.5 mm marking ends
Length: 11 cm
Handle: 60 mm
Round bodied
Double ended

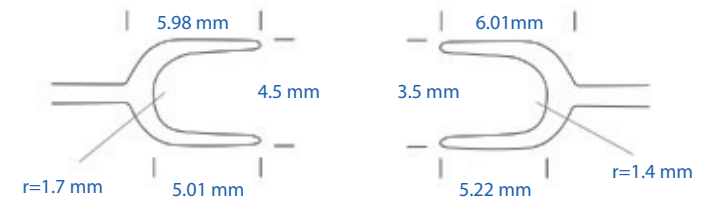

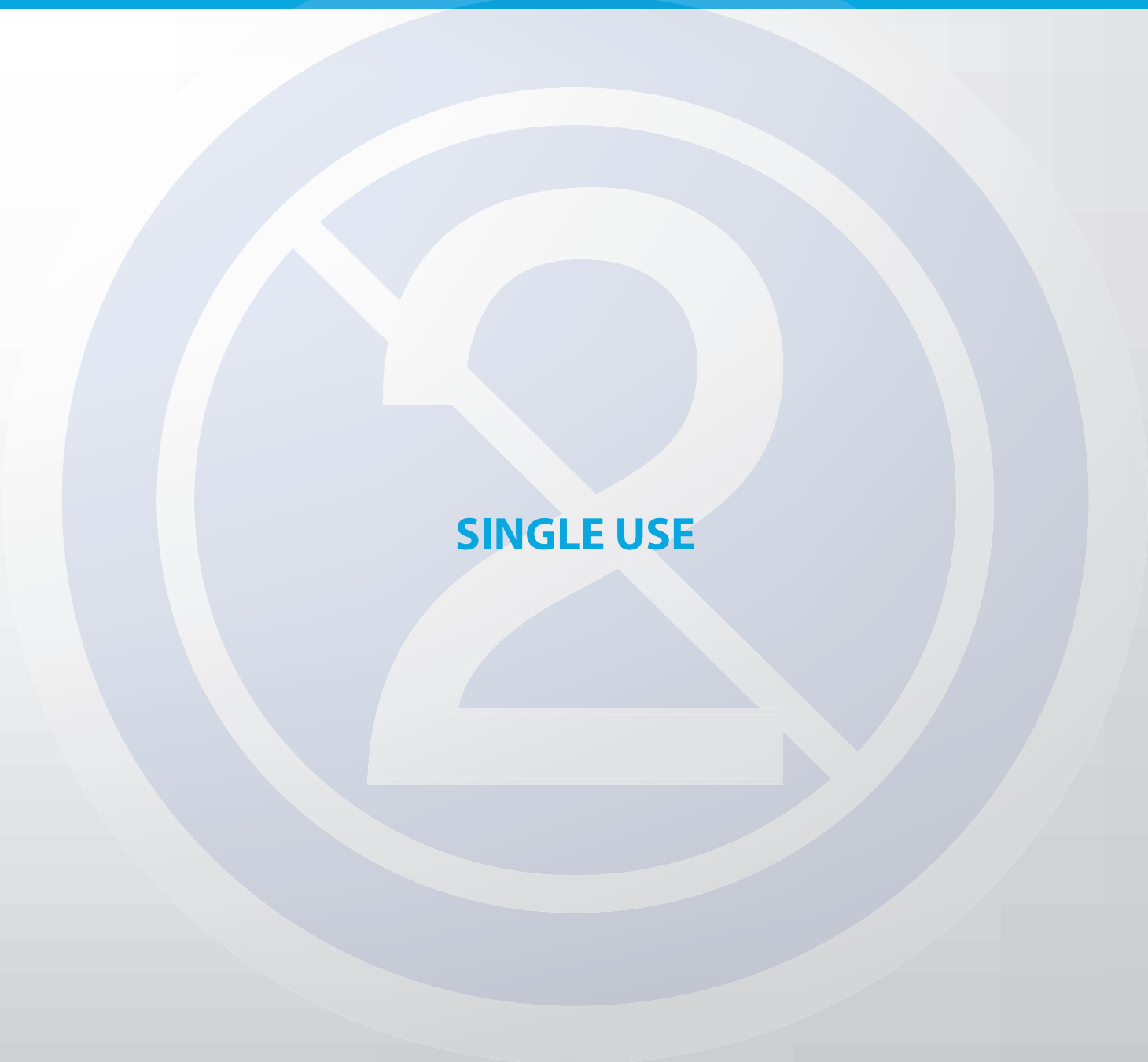

SINGLE USE



Curettes and Clamps



■ Single Use Instrument Code

Curette various size

Length: 11 cm
 Handle length: 80 mm
 ■ CR02 Curette medium, 2.5 mm diameter chalazion curette
 ■ CR03 Curette large, 4 mm oval shaped chalazion curette



CURETTES

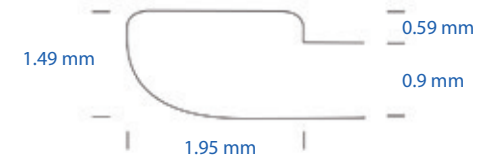

Curette double ended - CR05

Length: 13cm
 Handle length: 65 mm
 chalazion curette 2.5 mm diameter end and oval end



CLAMPS

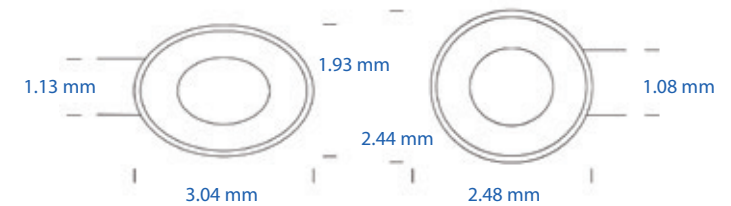

Chalazion clamp small - CS01

Length: 11.5 cm
 Handle length: 82 mm
 12 mm diameter plate



CLAMPS

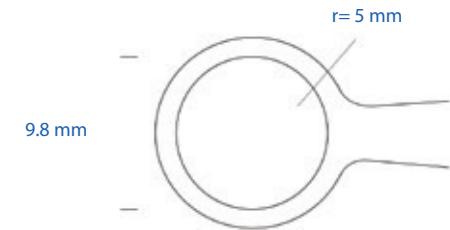

Chalazion clamp medium - CS03

Length: 90 mm
 Handle length: 54 mm
 19 mm diameter plate



CLAMPS

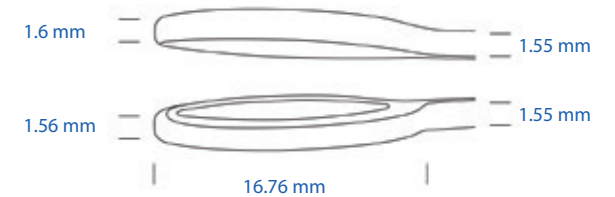

Chalazion clamp large - CS02

Length: 85 mm
 Handle length: 53 mm
 21 mm diameter oval plate



CLAMPS

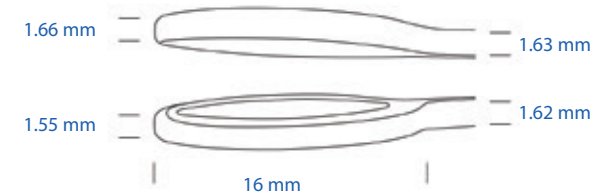

Needle holders



■ Single Use Instrument Code

Barraquer needle holder curved • SC142

Length: 11.5 cm
 Handle length: 82 mm
 12 mm diameter plate
 Round bodied

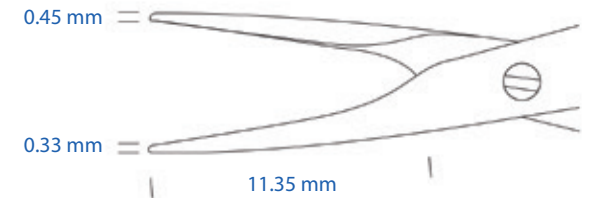

Castroviejo needle holder locking • SC118

Length: 14 cm

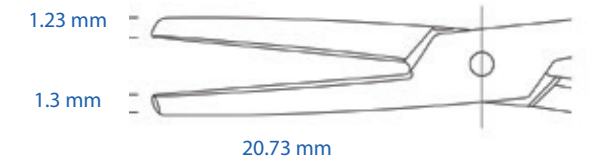

Needle holder blunt lock • SC62

Length: 13.5 cm
 Handle length: 82 mm

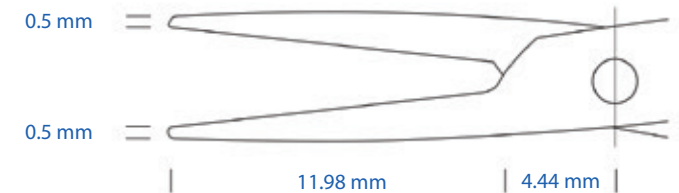

Needle holder curved • SC114

Length: 10 cm
 Handle length: 75 mm

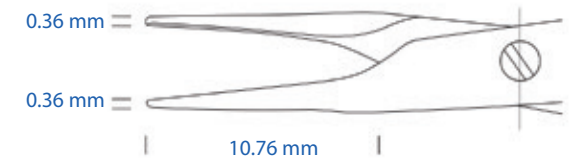

Suture needle holder curved • SC61

Length: 13.5 mm
 Handle length: 86 mm
 6 mm jaw

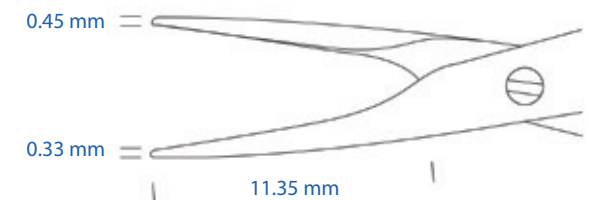

Lacrimal

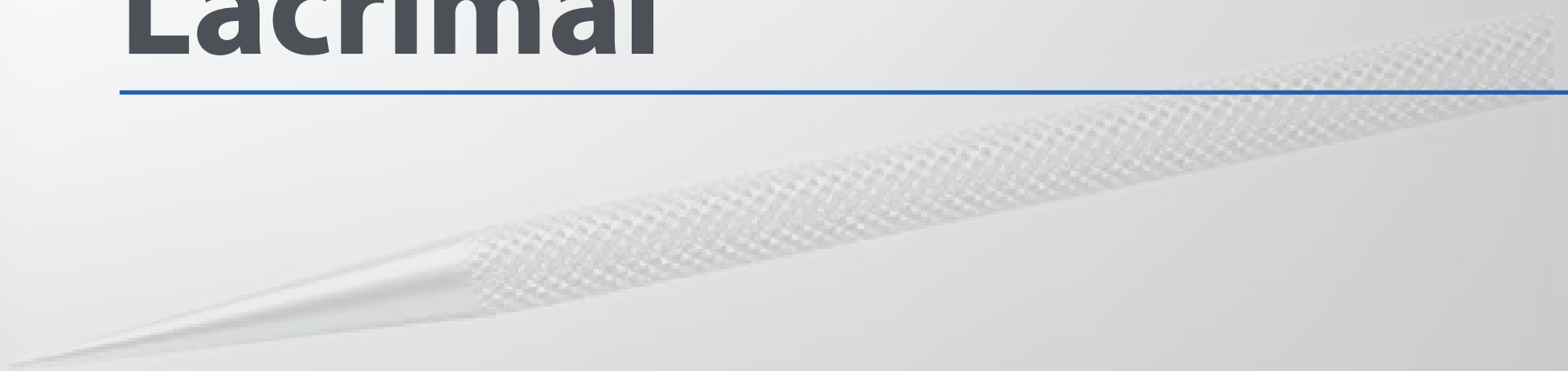

■ Single Use Instrument Code

Bowmans Probe size 00-0 double ended • PD05

Length: 50 mm
Handle length: 30 mm



Bowmans Probe size 000-00 double ended • PD06

Length: 50 mm
Handle length: 30 mm



Lacrimal probe • PD08

Length: 95 mm
Handle length: 15 mm
0.5 mm pointed end

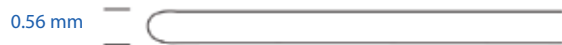

Punctal dilator blunt • PD02

Length: 95 mm
Handle length: 80 mm
0.4 mm pointed sharp end
Round bodied



Punctal dilator double ended - PD03

Length: 11.5 cm
 Handle length: 85 mm
 0.4 and 0.3 mm sharp pointed ends
 Round bodied

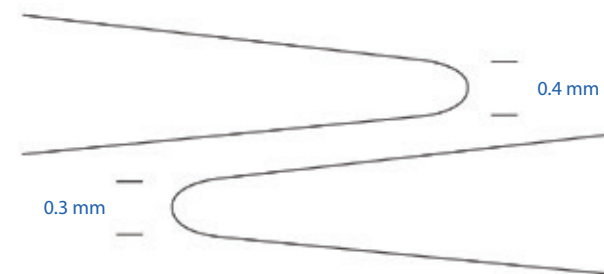
**Punctal dilator sharp - PD01**

Length: 95 mm
 Handle length: 78 mm
 0.2 mm pointed sharp end
 Round bodied

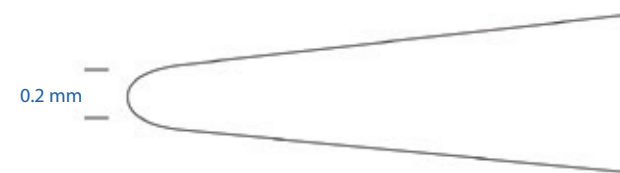
**Punctal dilator short - PD04**

Length: 50 mm
 Handle length: 30 mm
 0.3 mm sharp pointed ends
 Round bodied

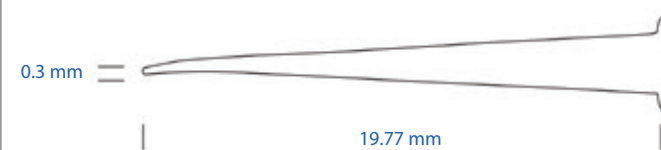
**Punctal dilator & lacrimal probe double ended - PD07**

Length: 14 cm
 Handle length: 70 mm
 curved and pointed end





CAPSULORHEXIS CAPSULORHEXIS KAPSULORHEXIS - Pg7-9

SC33	CAPSULORHEXIS FORCEPS CROSS ACTION
SC154	CAPSULORHEXIS FORCEPS CROSS ACTION
SC32	CAPSULORHEXIS FORCEPS CURVED
SC34	CAPSULORHEXIS FORCEPS ROUND BODIED
SC30	CAPSULORHEXIS FORCEPS STRAIGHT
SC3	CAPSULORHEXIS FORCEPS STRAIGHT
SC33M	MICS CAPSULORHEXIS FORCEPS CROSS ACTION
SC29	CAPSULORHEXIS FORCEPS CURVED
SC29M	MICS CAPSULORHEXIS FORCEPS CURVED
SC34M	MICS CAPSULORHEXIS FORCEPS ROUND BODIED CURVED
SCM01	MICS FORCEPS STRAIGHT
SC133M	MICS CAPSULORHEXIS FORCEPS STRAIGHT TIPPED
SC134M	MICS CAPSULORHEXIS FORCEPS ROUND BODIED STRAIGHT TIPPED
SC34M	CAPSULORHEXIS ROUND BODIED CURVED Pince Capsulorhexis Manche Rond / Courbe Kapsulorhexispinzette gebogen runder Griff
SC29M	MICS CAPSULORHEXIS FORCEPS CURVED Pince Capsulorhexis MICS Courbe / MICS Kapsulorhexispinzette gebogen

FIXATION FORCEPS / PINCES / PINZETTEN - Pg10-12

SC59	ADSONS DISSECTION FORCEPS / Pince d'Adson à Griffes / Adson Dissektionspinzette
SC56	BISHOPS FORCEPS / Pince de Bishop / Bishops Pinzette
SC38	BONN FORCEPS / Pince de Bonn/ à Griffes/ Manche court / Irispinzette/ Bonn/ kurzer Griff
SC129	BONN FORCEPS / Pince de Bonn/ à Griffes/ Manche long / Irispinzette/ Bonn/ langer Griff
SC22	COLIBRI TOOTHED FORCEPS / Pince Colibri/ à Griffes/ Manche long / Kolibri Pinzette/ gezahnt/ langer Griff
SC20	COLIBRI TYING FORCEPS / Pince Colibri/ à Griffes/ Manche court / Kolibri Pinzette/ gezahnt/ kurzer Griff
SC115	FINE CLAW FORCEPS / Pince à Griffes Fines / feine Greifpinzette
SC55	HOSKINS FORCEPS / Pince de Hoskins / Hoskins Pinzette
SC116	IRIS FORCEPS / Pince à iris/ griffes fines / Irispinzette/ gezahnt/ sehr fein
SC128	IRIS FORCEPS POINTED / Pince à iris/ Extrémités pointues/ Mors striés / Irispinzette/ gerade/ gerieft
SC117	JAYLES FORCEPS / Pince de Jayles / Jayles Pinzette
SC49	STRAIGHT NOTCHED FORCEPS / Pince à fixer alvéolée de Hoskins / Hoskins Pinzette gerade
SC54	ST. MARTINS FORCEPS / Pince de Paufigue / St. Martins Pinzette
SC21	STRAIGHT TOOTHED FORCEPS FINE / Pince à Tissus, droite / Pinzette gerade, fein mit Zähnen

GENERAL FORCEPS / PINCES / PINZETTEN - Pg13-15

SC119	ADSONS FORCEPS / Pince d'Adson, Mors striés / Adson anatomische Pinzette, gerieft
SC113	ADSONS FORCEPS FINE SERRATED / Pince d'Adson, Striée, Fine / Adson anatomische Pinzette, gerieft, sehr fein

SC104	DENIS SCLERECTOMY FORCEPS / Pince à sclérectomie de Denis / Denis Sclerectomy Pinzette
SC58	EPILATION - CILIA FORCEPS / Pince à Cil / Fremdkörper & Zilienpinzette
SC127	EPILATION FORCEPS / Pince à épiler / Zilien-und Fremdkörperpinzette
SC60	JEWELLERS FORCEPS / Pince de Joailler / Feine Fadenpinzette (Jewellers)
SA12	MOORFIELDS FORCEPS / Pince de Moorfield / Moorfield Pinzette
SA17	MOORFIELDS FORCEPS FINE / Pince de Moorfield Pointes fines / Moorfield Pinzette,fein
SG02	MOSQUITO FORCEPS / Pince Mosquito / Mosquito Pinzette

LENS FORCEPS / PINCES / PINZETTEN - Pg16

SC112	IOL REMOVAL FORCEPS / Pince à extraction d'implant / IOL Explantations Pinzette
SC112	IOL REMOVAL FORCEPS
SC51	LENS FOLDING FORCEPS / Pince à implants / IOL Faltpinzette
SC52	LENS IMPLANTATION FORCEPS / Pince à implantation IOL / IOL Implantations Pinzette

TYING FORCEPS / PINCES / PINZETTEN - Pg16

SC50	CURVED NOTCHED FORCEPS / Pince de Troutman / gebogene chirurgische Pinzette
SC73	KELMAN MC PHERSON FORCEPS / Pince Kelman McPherson / Kelman Mc Pherson Pinzette
SC72	MC PHERSON TYING FORCEPS / Pince McPherson / Angewinkelte Fadenpinzette (McPherson)
SC19	STRAIGHT TYING FORCEPS / Pince à fil droite, MC / Knüpf-/Fadenpinzette gerade
SC71	STRAIGHT TYING FORCEPS / Pince à fil droite, ML / Knüpf-/Fadenpinzette gerad
SC120	SUTURE REMOVAL FORCEPS CURVED / Pince à sutures, courbe / Fadenpinzette zur Nahtentfernung, gebogen
SC105	TROUTMAN TYING FORCEPS CURVED / Pince monofilament de Troutman / Knüpfpinzette nach Troutman, gebogen

MANIPULATORS & CHOPPERS / MANIPULATEURS & CHOPPERS / MANIPULATEUREN & CHOPPER Pg19-23

SC39	CHOPPER AND DIALLER / Double Manipulateur Chopper/Y / Chopper und Spalter
SC95	CHOPPER AND KLUGEN DOUBLE ENDED
SC97	DENIS CLEAVER / Cliver de Denis / Denis Spalter
SC89	DRYSDALE MICRO MANIPULATOR
SC47	DRYSDALE NUCLEUS SPATULA
SC100	GOVAN MANIPULATOR / Manipulateur Govan / Govan Manipulator
SC102	GOVAN MANIPULATOR AND PHACO CHOPPER / Chopper Phaco & Manipulateur Govan / Govan Manipulator & Phako Chopper
SC45	GREENS CHOPPER / Chopper de Greens / Greens Chopper
SC63	IRIS REPOSITOR / Manipulateur à iris / Iris Repositor
SC90	JONES CHOPPER / Chopper Jones / Jones Chopper
SC44	KOCH CHOPPER / Chopper Koch / Koch Chopper
SC143	KOCH PHACO SPATULA / Spatule de Koch / Phako Spatel nach Koch
SC106	LE BUISSON MANIPULATOR / Manipulateur Le Buisson / Le Buisson Manipulator
SC46	LENS DIALER (SINSKEY HOOK) / Crochet de Sinskey / Linsenhäkchen nach Sinskey

- SC146** LESTER HOOK / Crochet de Lester / Lester Haken
SC48 MUSHROOM NUCLEUS MANIPULATOR / Manipulateur champignon / Mushroom Nukleus Manipulator
SC147 PHACO CHOPPER AND MUSHROOM MANIPULATOR DOUBLE ENDED / Manipulateur Double Chopper-
 Champignon / Phaco Chopper und Mushroom Manipulator (Kombi-Instrument)
SC43 PHACO CHOPPER / Chopper Phaco / Phako Chopper
SC42 PHACO CHOPPER CLAW / Chopper Claw, fin / Phako Claw Chopper (krallen förmig, fein)
SC101 PISACANO ROTATOR AND NEUHANN MANIPULATOR DOUBLE END / Manipulateur double Pisacano-
 Neuhann / Pisacano-Neuhann Manipulator (Kombi-instrument)
SC144 SINSKEY HOOK AND GOVAN MANIPULATOR DOUBLE ENDED / Manipulateur double Sinskey-Govan /
 Sinskey Häkchen und Govan Manipulator (Kombi-Instrument)
SC41 Y SHAPED NUCLEUS ROTATOR / Manipulateur de Noyau Y, Vertical / Y-Nukleus Rotator

SPECULUMS / BLEPHAROSTATS / LIDSPERRER - Pg25-27

- SC01** BROAD GAUGE WIRE SPECULUM / Blépharostat fils large / Breiter Gauge Draht Lidsperrerr
SC124 HEAVY GAUGE WIRE SPECULUM OPEN LOOP / Blépharostat fil, grand diamètre / Drahtlidsperrerr groß,
 offen
SC09 KRATZ BARRAQUER CLOSED LOOP / Blépharostat de Barraquer, fenêtré / Lidsperrerr nach Kratz,
 gefenstert
SC132 KRATZ BARRAQUER CLOSED LOOP SPECULUM / Blépharostat Kratz-Barraquer, fenêtré / Lidsperrerr Kratz-
 Barraquer, gefenstert
SC11 KRATZ BARRAQUER OPEN LOOP WIRE SPECULUM
SC107 KRATZ OPEN LOOP WIRE SPECULUM (BLUE) / Blépharostat de Kratz (bleu) / Kratz Lidsperrerr mit offenen
 Valven (Blau)
SC05 KRATZ SOLID BLADED WIRE SPECULUM / Blépharostat Kratz-Barraquer, anses pleines (Chrome) / Kratz-
 Barraquer Lidsperrerr, Valven aus Chrom (solid)
SC13 KRATZ CLOSED LOOP SPECULUM / Blépharostat temporal de Barraquer / Lidsperrerr nach Barraquer,
 feiner gebogener Draht temporal offen
SC150 OPEN LOOP WIRE SPECULUM
SC155 SPECULUM OPEN LOOP
 TEMPORAL SPECULUM / Blépharostat temporal de Kratz / Lidsperrerr nach Kratz, feiner gebogener
SC12 Draht temporal offen
 WIDE ANGLED CLOSED LOOP SPECULUM
SC07 CLOSED LOOP WIDE SPECULUM / Blépharostat anses fils large / Spekulum/Lidsperrerr mit
SC07 geschlossenen Valven

SPECULUMS MECHANICAL - Pg27-28

- SC03** BANGERTER ADULT SPECULUM / Blépharostat de Bangertter / Lidsperrerr für Erwachsene nach Bangertter
SR10 BLADED ADJUSTABLE SPECULUM / Blépharostat mécanique, anses pleines / Lidsperrerr nach Barraquer,
 Valven aus Vollmaterial
SR11 KRATZ SCREW ADJUSTABLE WIRE SPECULUM OPEN LOOP / Blépharostat mécanique Kratz, anses fil /
 mechanisches verstellbarer Lidsperrerr nach Kratz (feiner gebogener Draht) temporal offen

- SC126** CLARKE SPECULUM / Blépharostat de Clarke / Clarke Lidsperrerr
SC121 Lieberman Speculum
SC08 SOLID BLADED SCREW ADJUSTABLE SPECULUM / Blépharostat mécanique / Mechanisch feststellbarer
 Lidsperrerr mit Valven aus Vollmaterial

PAEDIATRIC SPECULUM - Pg29

- SC10** KRATZ PAEDIATRIC CLOSED LOOP 10 MM SPECULUM / Blépharostat pédiatrique de Kratz /
 paediatrischer Lidsperrerr nach Kratz 10mm
SC103 NEONATE PAEDIATRIC SPECULUM / Blépharostat néonatal Necker / Neonatal paediatrischer Lidsperrerr
SC15 NEONATE 4 MM SPECULUM / Blépharostat néonatal 4mm / Neonatal Lidsperrerr 4mm
SC14 PAEDIATRIC 6 MM SPECULUM / Blépharostat pédiatrique 6mm / paediatrischer Lidsperrerr 6mm

SCISSORS / CISEAUX / SCHEREN - Pg31-33

- SC82/83** CASTROVIEJO CORNEAL SCISSORS RIGHT AND LEFT / Ciseaux de Castroviejo droite et gauche /
 Castroviejo Cornea Schere rechts und links
SC111 CASTROVIEJO SCISSORS STRAIGHT / Ciseaux de Castroviejo, droits / Castroviejo Schere, gerade
SC110 CASTROVIEJO SCISSORS STRAIGHT & ROUND / Ciseaux de Castroviejo, courbes, mousses / Castroviejo
 Mikro-Schere, gebogen, stumpf
SC80 ONG IRIS SCISSORS / Ciseaux ONG / ONG Iris Schere
SC109 OSHER SCISSORS / Ciseaux à implant (Osher) / Osher Schere
SA13 STALLARD CORNEAL SCISSORS / Ciseaux de Stallard / Stallard Hornhautschere
SC81 VANNAS SCISSORS / Ciseaux de Vannas / Vannas Schere
SC108 VANNAS SCISSORS CURVED / Ciseaux de Vannas, courbes / Vannas Schere gebogen
SA11 WESTCOTT CONJUNCTIVAL SCISSORS / ciseaux de Westcott, courbes / Westcott Bindeha
 utschere
SA14 WESTCOTT SCISSORS DOLPHIN NOSE / Ciseaux de Westcott, extrémités émoussées (en forme de
 dauphin) / Westcott Schere, stumpfe Enden (delphinförmig)
SA15 WESTCOTT DOLPHIN NOSE SCISSORS BLUNT TIPPED

SCISSORS GENERAL / CISEAUX / SCHEREN - Pg33-35

- SG35** DRESSING SCISSORS / Ciseaux à disséquer, extrémités courbes et mousses / Verbandschere gebogen
 mit abgerundete Spitze
SG34 ENUCLEATION SCISSORS / Ciseaux à énucléation / Enucléationsschere
SG14 GENERAL LONG HANDLE SCISSORS BLUNT END / Ciseaux courbes, bout mousse, manche long /
 Augenschere lang, stumpfe Enden
SG06 GENERAL SCISSORS BLUNT END / Ciseaux courts, pointes droites, bout mousse / Augenschere, stumpfe
 Enden
SG01 GENERAL SCISSORS SHARP POINTED / Ciseaux courts pointus / Augenschere, spitze Enden
SC96 IRIS SCISSOR
SG30 METZENBAUM SCISSORS CURVED POINTED / Ciseaux de Metzenbaum, courbes, pointus / Metzebaum
 Schere, gebogen, spitz

- SG07** STRABISMUS SCISSORS / Ciseaux à strabisme / Strabismus Schere
SG23 STEVENS SCISSORS CURVED / Ciseaux de Stevens courbes / Schere nach Stevens, gebogen
SG31 STEVENS TENOTOMY SCISSORS POINTED

GENERAL OPHTHALMIC / OPHTHALMOLOGIE GENERALE/ ALLGEMEINE OPHTHALMOLOGIE - Pg37-40

- SG32** BALL TIP MUSCLE HOOK / Crochet à muscle, point boule / Schielhäkchen, ballförmige Spitze
SG92 BULLDOG CLIP / Bulldog Clip / Bulldog Clip
SC91 CHAVASSE HOOK / Crochet de Chavasse / Chavasse Häkchen
SG20 DESMARRES RETRACTOR / Retracteur de Desmarre / Desmarres Retraktor
SG17 EYELID PLATE / Plaque à paupière de Jaeger / Lidplatte
SG28 GILLIES HOOK SMALL
SG37 GUTHRIE HOOK / Crochet de Guthrie / Guthrie Häkchen
- SG33** HALSTEAD MOSQUITO FORCEPS STRAIGHT / Pince de Halstead, droite / Halstead Arterienklemme, gerade
SG10 JAMESON STRABISMUS HOOK 5 MM / Crochet à strabisme de Jameson / Jameson Schielhaken
SG15 KUGLEN HOOK
SG22 MOSQUITO FORCEPS CURVED / Pince Mosquito, courbe / Mosquito Pinzette, gebogen
SC23 SCLERAL DEPRESSOR BULBOUS END / Dépresseur scléral / Skleral Depressor wulstige Enden
SC25 SCLERAL DEPRESSOR DOUBLE ENDED / Dépresseur scléral double de Schocket / Skleral Depressor zweiseitig
SC24 SCLERAL DEPRESSOR HAMMER END / Dépresseur scléral courbe / Skleral Depressor hammerförmiges Ende
SG12 THORNTON FIXATION RING
SG13 THORNTON FIXATION RING STANDARD 16 MM / Anneau de fixation de Thornton 16mm / Thornton Fixationsring standard 16mm
SG03 TRABECULECTOMY PUNCH / Punch à trabéculectomie / Trabekulotomie

CORNEAL & REFRACTIVE / CORNEE & REFRACTIVE / KORNEAL & REFRAKTIV - Pg43-50

- SR41** ALCOHOL WELL VARIOUS SIZES / Anneau marqueur / Lasek Alkohol Trichter
SR42 ALCOHOL WELL VARIOUS SIZES / Anneau marqueur / Lasek Alkohol Trichter
SR43 ALCOHOL WELL VARIOUS SIZES / Anneau marqueur / Lasek Alkohol Trichter
SR109 DMEK BERNHEIM HOOK / Crochet DMEK de Bernheim / DMEK Häkchen nach Bernheim
SR100 CORNEAL EPITHELIUM SPATULA ROUND / Spatule pour épithélium cornéen, ronde / Epithélium Hornhautspatel, rund
SR72 CORNEAL MARKER 8 LINE
SR40 CK LASIK MARKER / Marqueur LASIK avec croix de centrage / Hornhautmarker mit Fadenkreuz
SR04 CORNEAL RING PUSHER / Manipulateur anneau intra-cornéen / Manipulator für Cornealen Ring
SR05 CORNEAL RING POCKETING HOOK / Crochet anneau intra-cornéen / Taschen Haken für Cornealen Ring

- SR06** CORNEAL RING POCKET SPREADER / Spatule anneau intra-cornéen / Taschen Spreizer für Cornealen Ring
SR07 CORNEAL RING FORCEPS KERARING / Pince à anneau intra-cornéen - Keraring / Keraring Pinzette für Cornealen Ring
SR08 CORNEAL RING FORCEPS INTACS / Pince à anneau intra-cornéen - INTACS / Intacs Pinzette für Cornealen Ring
SR61 EPI PEELER RECTANGLE SHAPED / Scarificateur, forme D / Epi Peeler - quadratische Form (LASIK)
SR60 EPI PEELER D SHAPED / Scarificateur Micro-Houe / Epi Peeler, gebogen
SR51 EPI PEELER / Scarificateur cornéen / Epi Peeler
SR91 IMPLANTATION FORCEPS
SR34 INTRA LASIK FLAP SEPARATOR / Elévateur volet cornéen, crochet pointu / Intra-Lasik Flap Separator
SR102 KOCABA DMEK FORCEPS / P i n c e D M E K d e K o c a b a / K o c a b a D M E K P i n z e t t e
SR21 LASIK CORNEAL MARKER / Marqueur cornéen en fourche / Lasik Hornhautmarker
SR02 LASIK FEMTO SEPERATOR AND ELEVATOR DOUBLE ENDED / Séparateur-Élévateur Siebel / Lasik Femto Seperator und Elevator zweiseitig
SR31 LASIK FLAP ELEVATOR / Spatule Flap Lasik / LASIK Flap Heber
SR14 LASIK FLAP-LIFTING FORCEPS / Pince angulée mors long / Lasik Flap Hebebinzette
SR71 LASIK FLAP FORCEPS / Pince Flap Lasik / Lasik Flap Pinzette
SR103 LASIK FLAP SEPERATOR AND ELEVATOR DOUBLE END / Séparateur-élévateur LASIK, droit / Lasik Flap Separator / Flap Heber gerade
SR01 LENTICULE EXTRACTION FORECEPS
SR108 PATON SPATULA & SPOON DOUBLE ENDED / Spatule double de Paton / Paton Spatel und Löffel Zweiseitig
SR104 REINSTEIN LENTICULE SEPERATOR HOOK AND SPATULA DOUBLE END / Relex Crochet / Séparateur, Spatule / Relex Häkchen / Separator (Kombi-Instrument)
SR70 REINSTEIN LENTICULE SEPERATOR
SR101 S MARKER / Marqueur DMEK «S» / S Marker
SR03 SINSKEY AND REVERSE SINSKEY HOOK / Manipulateur double Sinskey-Sinskey inversé / Sinskey Häkchen umgekehrt Doppelinstrument
SR105 TREPHINE VARIOUS SIZES / Trépan cornéen / Trepane verschiedene Größen
SR106 TREPHINE VARIOUS SIZES / Trépan cornéen / Trepane verschiedene Größen
SR107 TREPHINE VARIOUS SIZES / Trépan cornéen / Trepane verschiedene Größen
SR110 TREPHINE VARIOUS SIZES / Trépan cornéen / Trepane verschiedene Größen

MEASURERS & MARKERS / MESUREURS & MARQUEURS / MESSINSTRUMENTE & MARKER - Pg53-54

- SG04** BRAUNSTEIN FIXED CALIPER 1.8 MM THICKNESS / Marqueur de Braunstein, métal / Braunstein Kaliber fix 1.8mm Dicke
SG05 CASTROVIEJO ADJUSTABLE CALIPER / Compas de Castroviejo, pointes droites / Castroviejo verstellbarer Zirkel
SC130 CORNEAL MARKER GUIDE
SG93 HELVESTON RULER / Règle d'Helveston / Helveston Meßspatel

- SC65** MENDEZ GAUGE / Anneau de Mendez / Messlehre nach Mendez (zur Bestimmung des Einschnittwinkels)
- SG19** SCLERAL MARKER ROUND BODIED DOUBLE ENDED / Marqueur scléral métal 3.5 mm - 4.5 mm / Skleral Marker runder Griff, zweiseitig

CURETTES & CLAMPS / CURETTES & PINCES / KURETTEN & KLEMMEN - Pg57

- CR01**
- CR02**
- CR03** CURETTE VARIOUS SIZES / Curettes à chalazion / Küretten verschieden Größen
- CR05** CURETTE DOUBLE ENDED / Curette double / Kürette zweiseitig
- CS01** CHALAZION CLAMP SMALL / Pince à chalazion 12mm / Chalazion Klemme klein
- CS02** CHALAZION CLAMP LARGE / Pince à chalazion large, ovale / Chalazion Klemme groß

NEEDLE HOLDERS / PORTE-AIGUILLES / NADELHALTER - Pg59

- SC142** BARRAQUER NEEDLE HOLDER CURVED / Porte-Aiguille de Barraquer, courbe / Barraquer Nadelhalter gebogen
- SC118** CASTROVIEJO NEEDLE HOLDER LOCKING / Porte-aiguille de Castroviejo droit, verrou / Castroviejo Nadelhalter mit Sperre
- SC62** NEEDLE HOLDER BLUNT LOCK / Porte-aiguille, bout mousse, verrou / Nadelhalter stumpf, mit Sperre
- SC114** NEEDLE HOLDER CURVED / Porte-aiguille, courbe / Nadelhalter, gebogen
- SC61** SUTURE NEEDLE HOLDER CURVED

LACRIMAL / LACRYMAL / LAKRIMAL - Pg61-62

- PD05** BOWMANS PROBE SIZE 00-0 DOUBLE ENDED / Sonde de Bowman double 00-0 / Tränenwegsonde Bowman Größe 00-0 zweiseitig
- PD06** BOWMANS PROBE SIZE 000-00 DOUBLE ENDED / Sonde de Bowman double 000-00 / Tränenwegsonde Bowman Größe 000-00 zweiseitig
- PD08** LACRIMAL PROBE / Sonde à voies lacrymales / Lakrimal Sonde
- PD02** PUNCTAL DILATOR BLUNT / Dilatateur voies lacrymales, mousse / Tränenwegsonde stumpf
- PD03** PUNCTAL DILATOR DOUBLE ENDED / Dilatateur voies lacrymales, fin-medium / Tränenwegsonde zweiseitig
- PD01** PUNCTAL DILATOR SHARP / Dilatateur voies lacrymales, très fin / Tränenwegsonde scharf
- PD04** PUNCTAL DILATOR SHORT / Dilatateur voies lacrymales, manche court / Tränenwegsonde kurz
- PD07** PUNCTAL DILATOR & LACRIMAL PROBE DOUBLE ENDED / Dilatateur-Sonde pour voies lacrymales / Tränenwegsonde zweiseitig





Surgitrac® Instruments Group Limited

10 Wharfside Business Park
Irlam Wharf Road
Manchester
M44 5PN
United Kingdom

+44 (0)161 776 7626
info@surgitrac.com