

IMPORTANT NOTICE

This product may malfunction due to electromagnetic waves caused by portable personal telephone, radio-controlled toys, etc. Please keep away any device that can influence this product.

The information in this manual is checked out carefully and is believed to be entirely accurate at the time of publication. However, MEDIZS Inc. takes no responsibilities of the results caused by default, omission, or misuse of it.

MEDIZS Inc. reserves the right to modify the product itself or specifications of the product without any prior notice, and is not required to update this documentation to reflect such changes.

Operation Manual ver 1.01 / 2015.10

© 2014 MEDIZS Inc.

94-10, Techno-2ro, Yuseong-gu, Daejeon,

305-509, Republic of Korea

All rights are reserved.

Under copyright laws, this manual may not be copied, in whole or in part, without the prior written consent of MEDIZS Inc.

CONTENTS

1. Introduction	4
1-1. Outline of Device	4
1-2. Features	4
2. Safety Information	5
2-1. Symbol information marked on the instrument	5
2-2. EU Countries	5
2-3. Safety Instruction	6
2-4. General Safety Information	7
2-5. Notes for using the instrument	8
3. Configurations	9
3-1. Main Body (Front view)	9
3-2. Main Body (Side and Rear view)	9
3-3. Remote Controller	11
3-4. Wireless control by iOS Application	13
4. Installation	15
4-1. Securing Main body with Wall mounting bracket	15
4-2. Securing Main Body with Stand Floor	16
5. Operating Instructions	18
5-1. Basic Operation	18
5-2. Usage of Remote control	18
5-3. Setting Screen	19
5-4. Chart program mode	23
5-5. How to control by iOS application	24
5-6. Setting on Application	28

6. Chart type	31
7. Maintenance and repair	35
8. Service Information.....	35
8-1. Information	35
8-2. Supply of spare parts.....	35
9. Specification.....	36
10. Components list.....	37

1. Introduction

1-1. Outline of Device

LC-13 is a visual acuity chart system that has been designed to present more than 90 various charts, Animation, Color-Blindness chart, etc on LED TFT LCD and WINCE system. Operator can control the system and select the charts by an IR remote controller. In contrast to other chart system, Smart LC-13 can be controlled by a tablet PC via Bluetooth communication, such as iPad and iPad mini.

1-2. Features











- LC-13 provides bright and clear screen using LED TFT LCD Panel and white uniform brightness of 250cd/m².
- High resolution LCD provides a wide range of testing option and sharper letter edge quality from VA 0.05 to VA 2.0 without aliasing.
- More than 90 various charts for LC-13 support all manners of tests for the visual acuity and visual functions, such as Astigmatism, Color Blindness, Strabismus, Heterophoria, Stereopsis, Binocular Balance, Binocular Fusion, Vision Suppression, Aniseikonia, etc.
- In accordance with refraction circumstance, the testing distance can be set in the range of 1.5 to 8 m in increments of 0.25 m. Even in less than 1.5 m, refraction is available with Mirror function. The chart size is reduced and enlarged as per the set refraction distance to keep the visual angle same.
- Using random adjustment function, the charts of a same visual acuity can be switched randomly. This prevents erroneous test result from the subject memorizing the charts.
- In accordance with refraction circumstance or patient's eye condition, white and black function, contrast function, or R/G adjustment function can be used.
- For easy refraction, LC-13 provides standard programmed test having 16 steps and 5 customized program having maximum 20 steps can be programmed by the user.
- High Resolution 19-inch LCD provides a wide range of testing option and sharper letter edge quality from the biggest and the smallest.
- Chart selection is performed by either IR Remote control or Table PC such as iPad or iPad mini. Bluetooth Chip approved by Apple Inc. is mounted on the device for stable wireless communication.
- Animation, Eye care information and Slide show may be displayed instead of Charts. Customized Images and Video also can be displayed.

2. Safety Information

2-1. Symbol information marked on the instrument

The International Electro-technical Commission (IEC) has established a set of symbols for medical electronic equipment which classify a connection or warn of any potential hazards. The classifications and symbol are shown below.

Save these instructions.

Symbol	Description
	Protective earth
	Alternating Current Power
	Caution
	Power Off (separated with power source)
	Power On (separated with power source)
	Do not throw away the waste to inappropriate place
	Manufacturer
	Date of Manufacture
	Authorized Representative in the European community
	Consult operating instructions

2-2. EU Countries

The following mark, the name & address of the EU Representative shows compliance of the instrument with Directive 93/42/EEC.













EU Representative:





CALMED INVEST Kft.

1182 Budapest, Fiume utca 3., Budapest, Hungary

2-3. Safety Instruction

If you see any warnings or cautions printed on the warning labels, follow the safety instructions in this manual. Ignoring such cautions or warnings while handling the product may result in injury or accident. Be sure to read and fully understand this manual before using this product. Keep this manual in easy-to-access place.

 WARNING	This indicates a potentially hazardous situation which could results in death or serious injury to you or others.
 CAUTION	This indicates hazardous situations which may result in minor injury to you or others, or may result in machine damage.
 CAUTION	Do not place the product on the floor in a multi- socket that is used to prevent damage to the liquid inlet.
 CAUTION	Single & Multi- specified socket , do not connect as well with additional multi-socket or extension cord .
 CAUTION	The maximum permissible value of the socket used for the product is less than 100 VA is not allowed.
 CAUTION	Such products and connections that are non- medical devices (video monitors , IT equipment, etc.) is connected directly to the wall socket with a high current flows .
 CAUTION	Multi-socket outlet must be a grounding -type type and must conform to IEC 60884-1.
 NOTE	This is used to emphasize essential information. Be sure to read this information to avoid incorrect operation.
 WARNING	Only operate the instrument with the power supply indicated on the rating plate. Otherwise, it may result in fire or electric shock.
 WARNING	Be sure to turn OFF the power switch before connecting or disconnecting the cables. Also, do not handle them with wet hands. Otherwise, you may get an electric shock that may result in death or serious injury.
 WARNING	Should any of the following occur, immediately turn OFF the power switch, unplug the power cable from the AC outlet, and contact the dealer or the agent who/where you purchase this instrument. •When there is smoke, strange odor or abnormal sound.

	<ul style="list-style-type: none"> ▪When liquid has been spilled into the instrument or a metal object has entered through an opening. ▪When the product has been dropped or its housing damaged.
 WARNING	Never disassemble or modify this instrument because it may result in fire or electric shock. Also, since this instrument incorporates high-voltage parts and other hazardous parts, touching them may cause death or serious injury.
 WARNING	IT devices used to connect a USB A / B connector must comply with the IEC60601-1 or IEC60950-1 standard.
 WARNING	Devices to prevent damage to the electrical shock should be connected to the power supply with the protective earth.
 WARNING	Be sure to perform Wait until cool enough to heat the lamp replacement lamp. Do not touch the lamp with bare hands ten thousand and one against. It can cause severe burns.
 WARNING	Do not Keep way the place where the temperatures very much.

2-4. General Safety Information

1. This instrument is used with accessories from MEDIZS Inc. If consumer would like to use the accessories from other manufacturers, safety of accessories should be verified and identified by manufacturer or by MEDIZS Inc.
2. Operation Manual should be kept at the place where the user can easily access.
3. When moving this instrument, please keep vibration or impact away from the equipment. It can bring some damage inside or outside of the instrument. Please carefully handle the instrument.
4. In case there is smoke, strange odor or noise on working, disconnect the power supply and consult the dealer.
5. To connect this instrument with other relevant equipment, consult with the dealer about the way to make it.
6. Don't use organic solution such as alcohol, thinner, benzene, etc. to clean the surface of this instrument. It may damage the instrument.
7. Do not arbitrarily disassemble or modify this instrument.

8. If you are not using this instrument a long time, disconnect the power supply and protect the unit with dust cover.
9. Do not pull power cable to disconnect from wall outlet.
Before every operation, visually check the equipment for exterior mechanical damage(s) and for proper function.

2-5. Notes for using the instrument

1. Caution

- ① Do not disassemble the instrument. It may cause malfunction or electric shock.
- ② Do not hit or drop the instrument. The instrument may be damaged if it receives a vibration or impact. It can bring some damage inside or outside of the instrument. Handle with care.
- ③ Be careful not to enter any dust or metal material into interior of the device.
- ④ Do not try to connect power cord in disconnection of spare parts. It can bring some damage on the device.

2. Storage place

- ① Not humid place and not in the vicinity of water.
 - Temperature : 10°C ~ 60°C
 - Relative humidity : 30 - 75%
- ② Not dusty and not in the vicinity of filthy place with salt or sulfur.
- ③ Not in the vicinity of vibration or shock.
- ④ Not in the vicinity of direct sunlight.

3. Check list

- ① Check the test distance setting.
- ② Make sure the device is installed steady.
- ③ Check the normal working of the device, if it is not working for a long time.
- ④ If the screen is not clean, wipe it with soft and dry cloth carefully to avoid any scratch.

3. Configurations

3-1. Main Body (Front view)

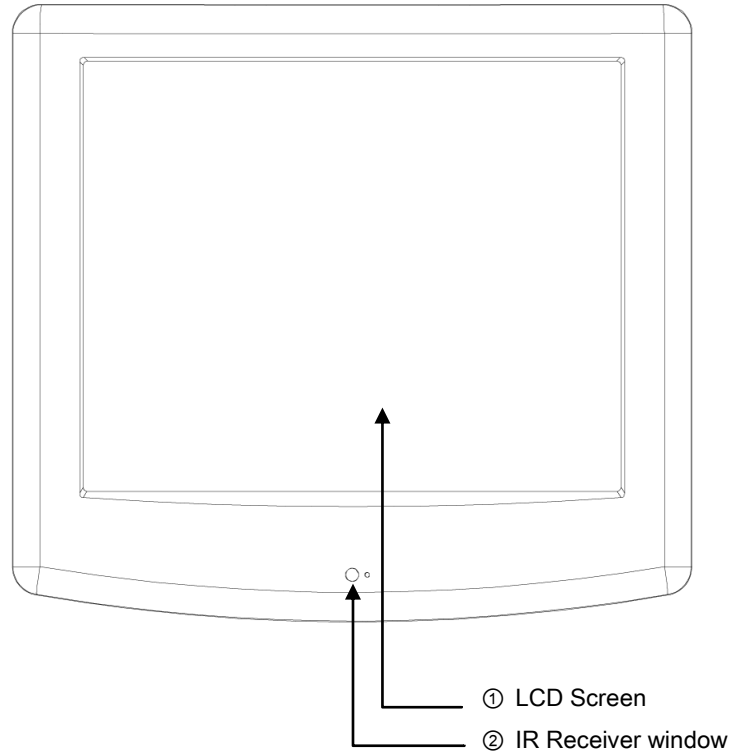

3-2. Main Body (Side and Rear view)

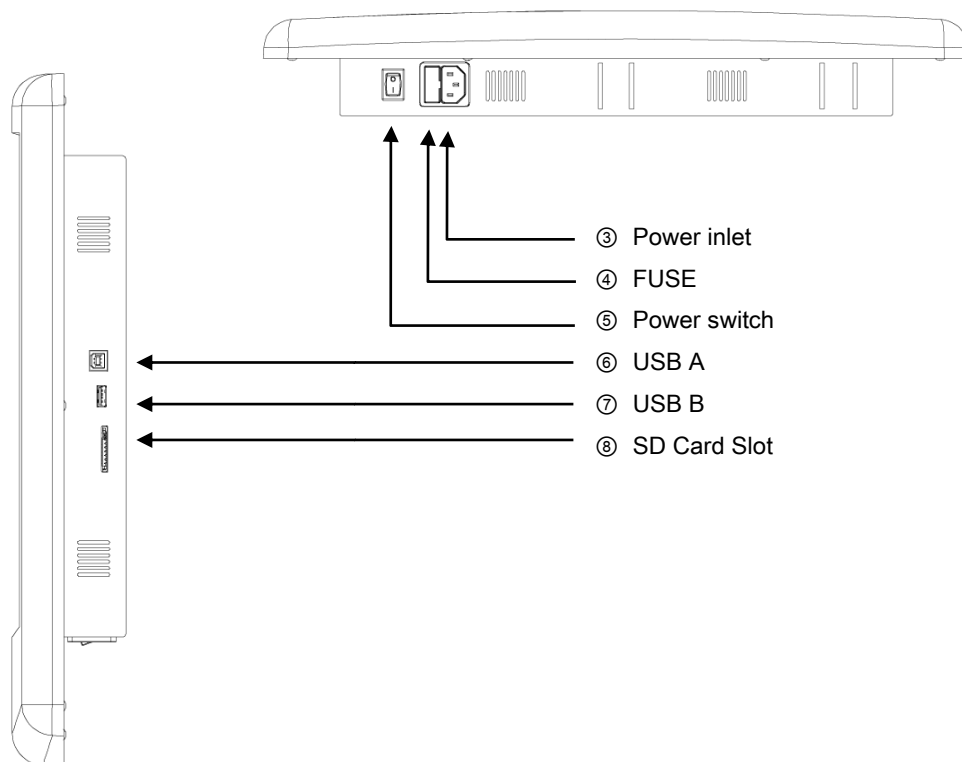

- ① LCD Screen:
 - Charts are presented on this LCD

- ② IR Receiver window:
 - Receives signals from the remote control.

- ③ Power Inlet:
 - Connector for power supply

- ④ FUSE

- ⑤ Power Switch:
 - Power ON/OFF

- ⑥ USB A:
 - Connector with external equipment

- ⑦ USB B:
 - For Upgrade

- ⑧ SD Card Slot:
 - For uploading Image and Video

3-3. Remote Controller

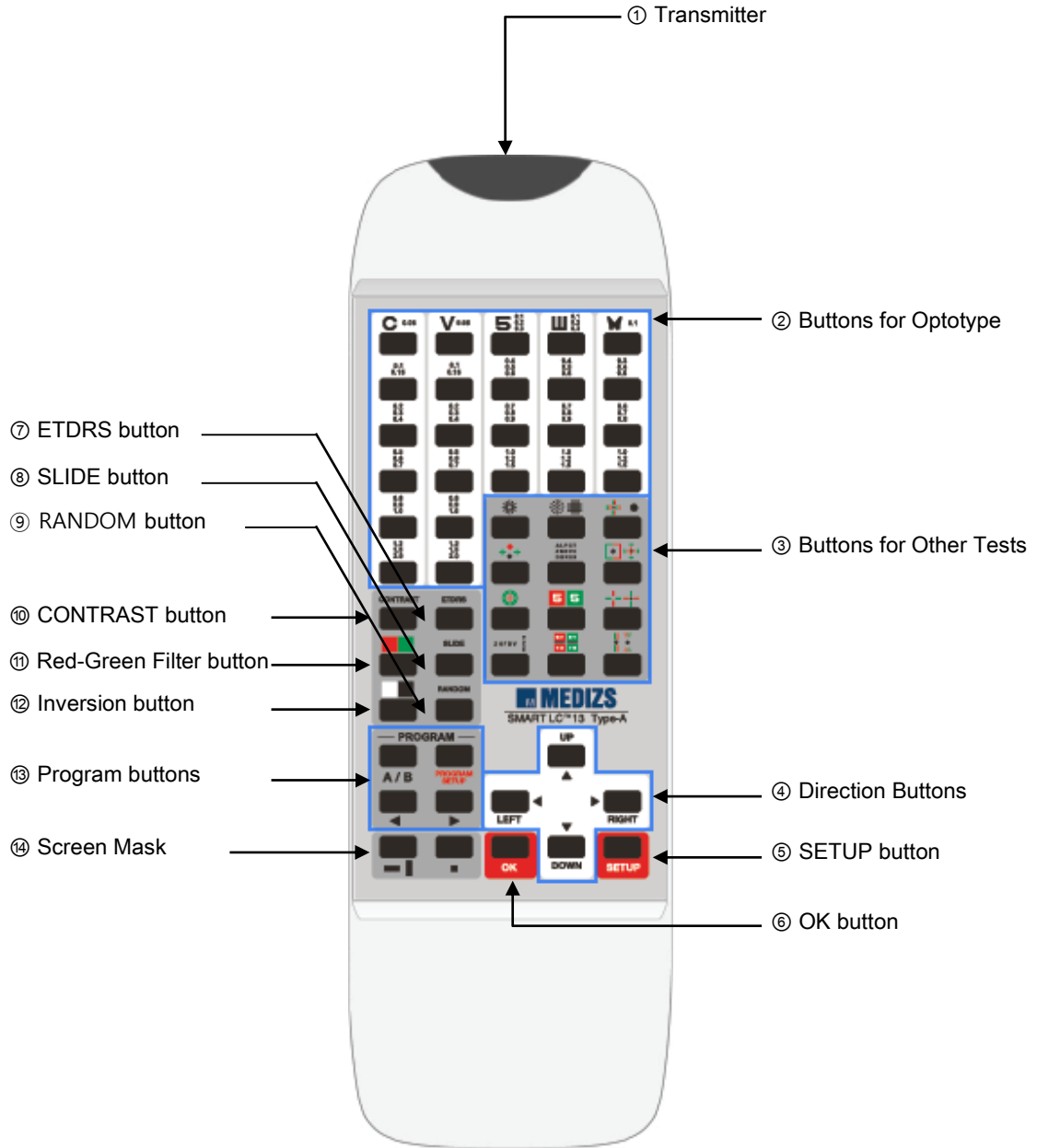

① Transmitter

- Sends a control signal to the main body

② Buttons for Optotype

- Used to select the type of the optotypes

③ Buttons for other tests

- Used to select the charts for other tests

④ Direction Buttons



- Move the position of the mask (Vertical line/Horizontal line/Single letter)

- Move the direction on SETUP screen

⑤ SETUP Button



- Enter SETUP screen to set beep sound, screen brightness, refraction distance, and color density of Red and Green filter.

⑥ OK button



- Set the option on Setup screen

⑦ ETDRS button



- Displays ETDRS charts

⑧ SLIDE button



- Display the slide show such as eye care information, color-blindness, eyeball exercise, animation, etc.

⑨ RANDOM button



- Randomly rearrange: er order at the same VA

⑩ CONTRAST button



- Selects the contrast of ts

⑪ Red-Green filter button



- Applies the red-green filter the VA charts

⑫ Inverse button



- Pressing the bu toggles between normal and inversed black and white displays

⑬ PROGRAM buttons

- Display the chart to be programmed by the user.

- : Pressing the button changes the program in the A/B Program A → B → C → D → E → A ...

- : Saves the displayed chart on selected program

- : Displays the chart in order to be pro by the user

⑭ Screen mask

- Select the mask (Vertical line/Horizontal line/Single letter)

3-4. Wireless control by iOS Application

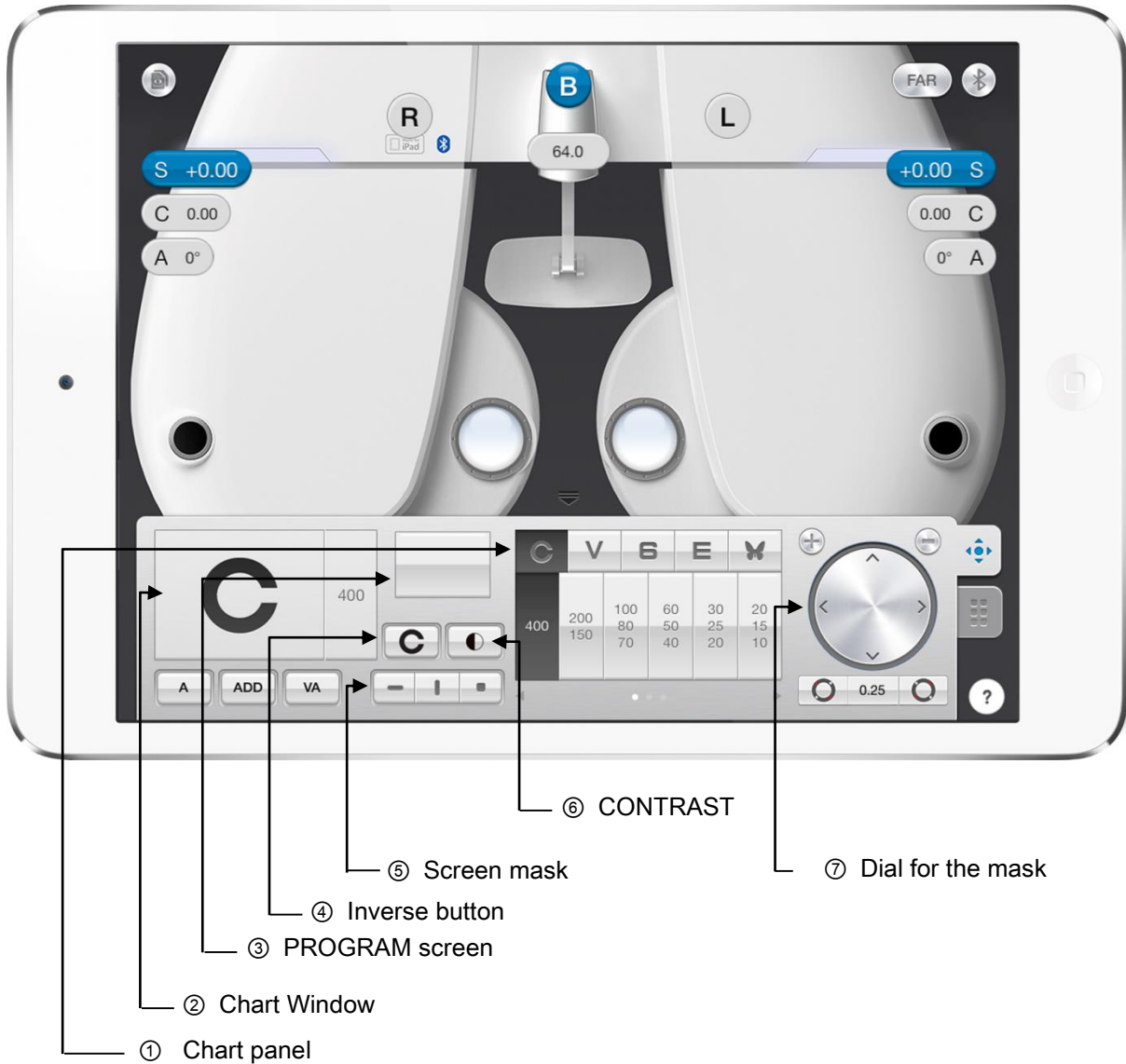











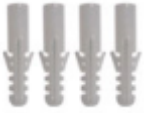

- ① Chart panel
 - Select the charts
 - By swiping on the panel, you can move to next page for other test
- ② Chart window
 - Displays the presented chart
- ③ Program screen
 - Displays the next chart on programmed test
- ④ Inverse button
 - Chart the chart between normal and inversed black-and-white displays
- ⑤ Screen mask
 - Selects the make
- ⑥ Contrast button
 - Appears the window for adjusting the contrast of charts
- ⑦ Dial for the mask
 - Moves the make on the VA chart

4. Installation

4-1. Securing Main body with Wall mounting bracket

Hang the LC-13 on a wall that is solid enough to support the weight (about 5kg) when using the wall mounting bracket. Reinforce the wall as needed.

Before installation, check that the following items are one set of wall mounting bracket.

Wall adhesion panel	Monitor adhesion panel
	
Screw	Plastic Anchor
	
4 Ø Washer	5 Ø Washer
	
6 Ø Washer	4*8mm
	
4*12mm	5*8mm
	
5*12mm	6*8mm
	
6*12mm	5*10mm
	

Follow the next step for installation.

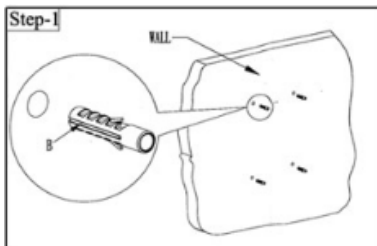

Step 1.

Make four holes 50mm deep to fit holder of wall adhesion panel by using diameter 8Ø. And then, put the B.Plastic anchor into four wholes.

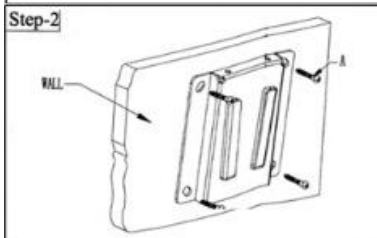

Step 2.

After put and fix the wall adhesion panel in wall, by inputting A.screw

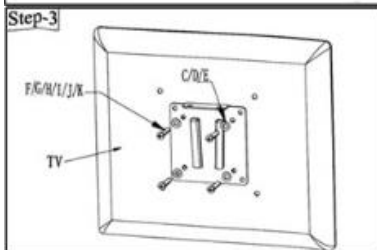

Step 3.

Select the washer (one of C,D,E) and screw (one of F,G,H,I,J,K) which fits in back holder size of LCD . And then fix the monitor adhesion panel.

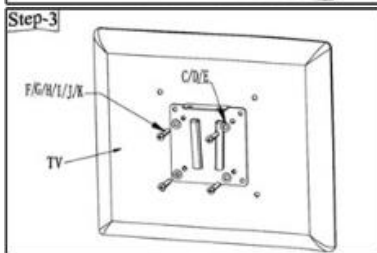

Step 4.

Hang a monitor adhesion panel on step 3 on the wall adhesion panel of step 2.

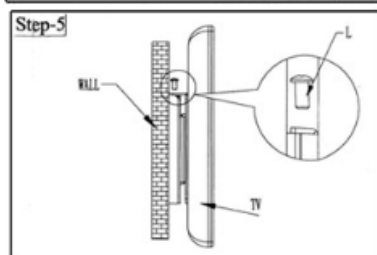

Step 5.

Insert two 5*10mm screws and fix the two panels.

4-2. Securing Main Body with Stand Floor

Please refer to ANNEX1.



Warning

- To prevent damage or injury caused by the flipping or falling of the device, do not install the device on a slanted surface.
- To prevent electric shocks, do not touch the plug with wet hands.
- Make sure to safely tighten the screws. If the screws are loose, the device might fall off and cause damage or injury.
- When installing the device on a wall, use a hanger provided by MEDIZS. Make sure the device is installed on a firm wall that can withstand the weight of the device. (Do not install the device on a plaster wall. The device might fall off and cause damage or injury.)
- When moving the device on the floor, make sure that two people hold the 'rack.' A single person handling the device could drop it and cause damage or injury. Improper installation of the device may deteriorate the test.
- Allow more than 5cm of space in the upper and lower area of the device, so that the ventilation opening is not blocked.
- Do not place any objects on the upper ventilation opening of the device. Overheating may cause damage or injury.

5. Operating Instructions

5-1. Basic Operation

- ① Turn on the power switch of LC-13
- ② White light will be shown on the IR receiver window
- ③ After loading, VA 0.05 Chart will be displayed.

5-2. Usage of Remote control

5-2-1. Slide Mode

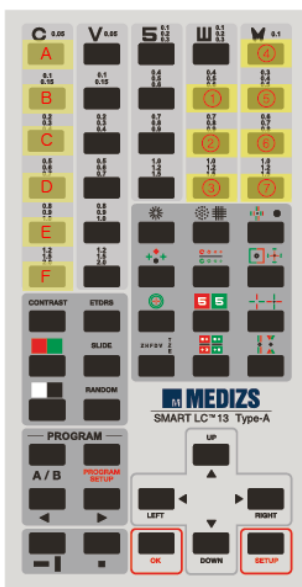

A. Press SLIDE button. ()

B. Select the followings

- ① Page for Eye care information
- ② Color Blindness
- ③ Amsler grid
- ④ Red / Green Images
- ⑤ Eyeball exercise Type A – 3 types
 - A. Horizontal
 - B. Vertical
 - C. Left-diagonal
 - D. Right-diagonal
 - E. Center
 - F. Random
- ⑦ Animation

5-2-2. SETUP

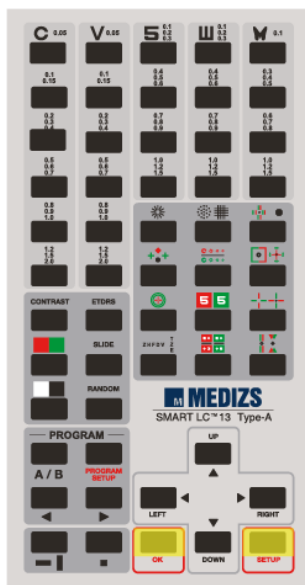

A. Press SETUP button

B. Move the Menu using direction buttons

C. Please OK button to apply setting option.

D. To return the chart screen, press SETUP button.

5-2-3. Change control channel

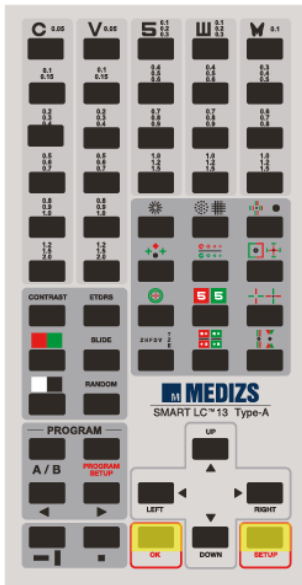

- A. Press SETUP button during pressing Horizon/Vertical mask button.
- B. It changes in the order CH3-Ch4-Ch1-CH2.

5-3. Setting Screen

On setting screen, there are 6 taps. You can control Chart type, Chart program, Vision Test, Display and setting option and also check information for the device.

5-3-1. Chart Type

On chart type tap, you can select the chart type, distance indication function and Mirror function.

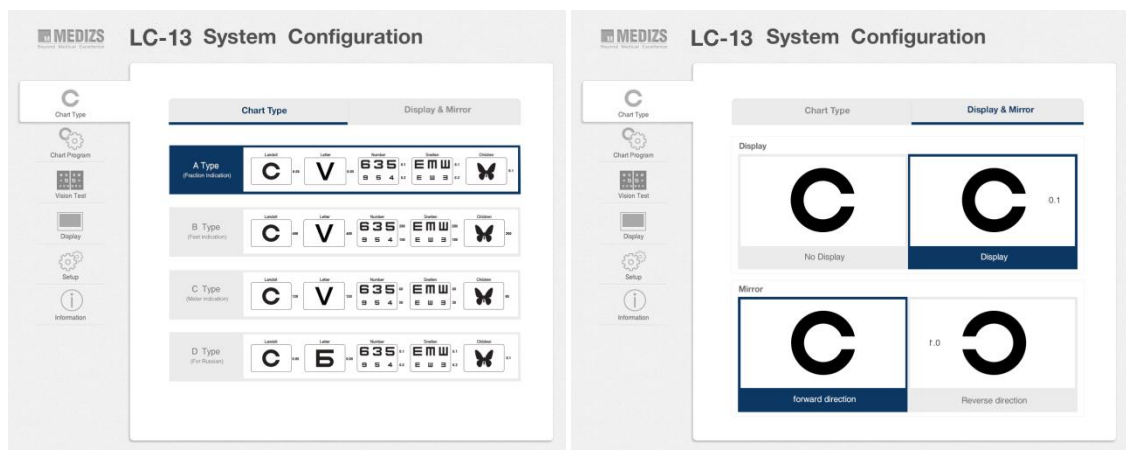

5-3-2. Chart Program

Customized program can be revised and deleted.

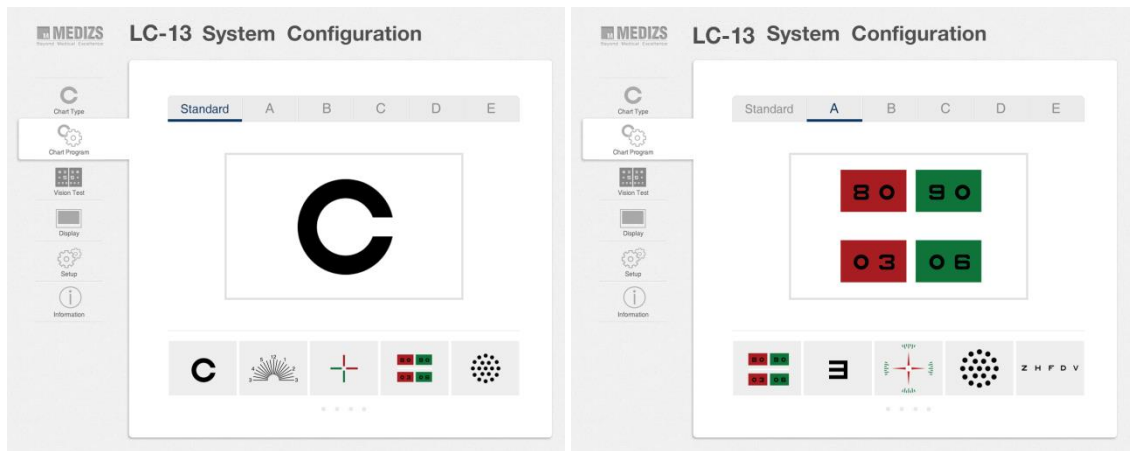

5-3-3. Vision Test

Select Clock Dial types, Phoria, and ETDRS.

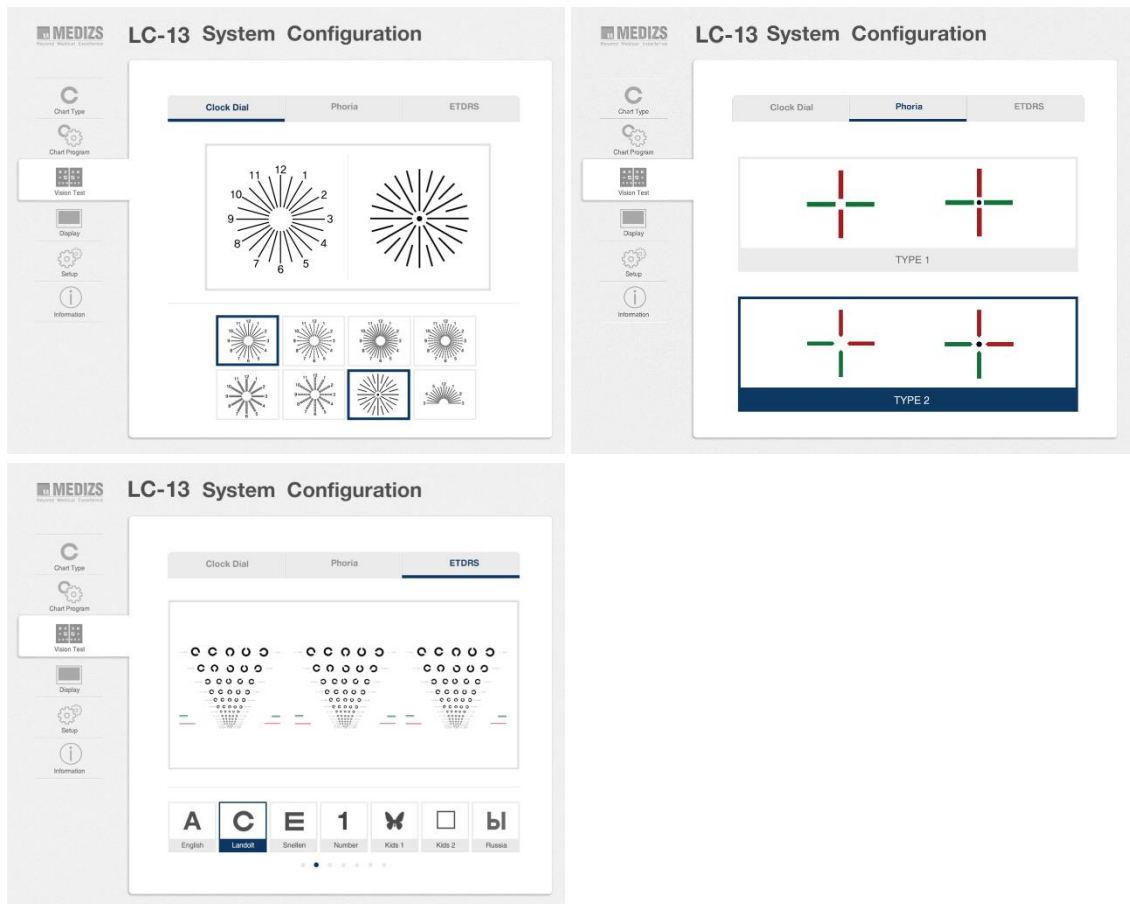

5-3-4. Display

- Red/Green: Color density of Red and Green filter can be adjusted.
- Distance: In accordance with refraction circumstance, the testing distance can be set in the range of 1.5 to 8 m in increments of 0.25 m.

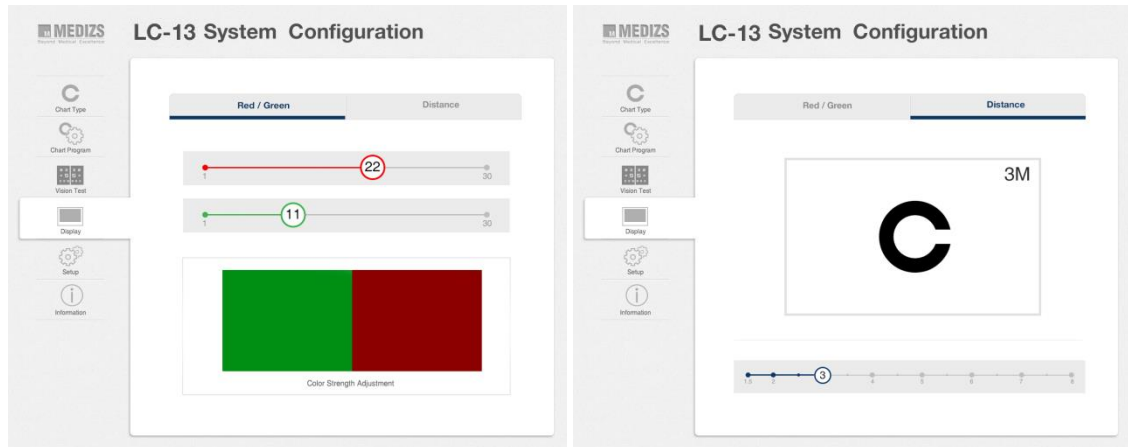

5-3-5. Setup

Set Screen saving time, Beep sound, and Screen brightness.

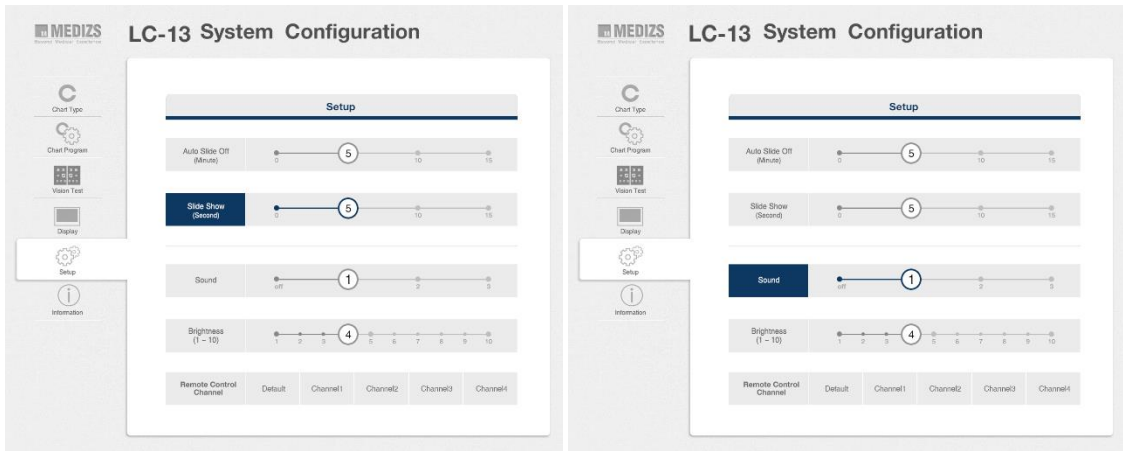

5-3-6. Information

You can check software version and manufacturer's information.

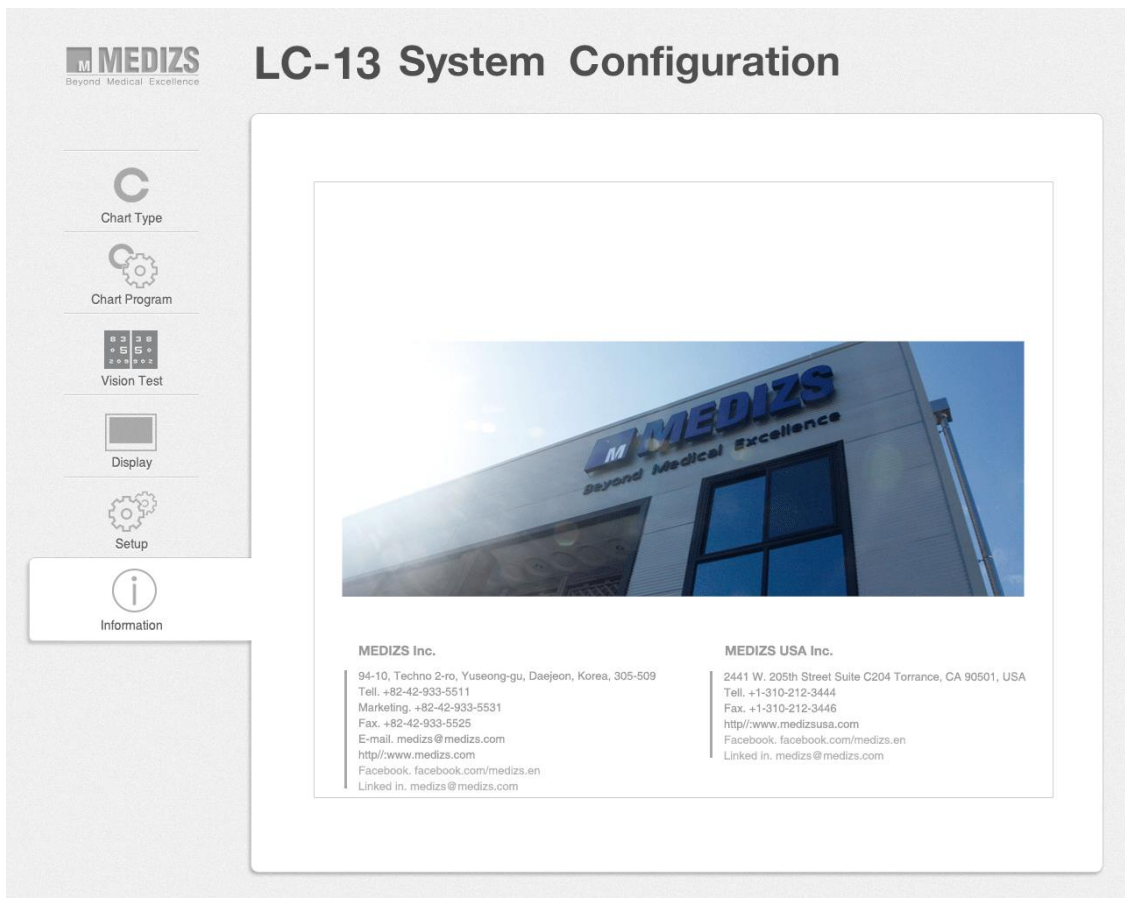

5-4. Chart program mode

5-4-1. Chart registration method.

5-4-1.1. Press the  button, and select mode.(A~E)

5-4-1.2. Select chart you want.

5-4-1.3. Press the  button, add the currently chart's information.

5-4-1.4. Repeat the above procedure to register the chart's information.

5-4-1.5. Registration is complete, next press the  button.

5-4-2. Show the program mode chart.

5-4-2.1. Press the  button, and select mode.(A~E)

5-4-2.2. Press the , it is show in regular sequence.

5-4-2.3. If press the  button, this mode is end.

5-4-3. Preview & Delete charts.

5-4-3.1. Press the  button.

5-4-3.2. Go to the Chart Program tab.

5-4-3.3. You can see the chart list.

5-4-3.4. Press the  button to enter the mode you want to delete.

5-4-3.5. Press the  button, popup the delete message.

5-4-3.6. If select the 'OK', it will be deleted and you select the 'CANCEL' it will be cancel.

5-5. How to control by iOS application

5-5-1. Chart and special chart.

- If you swipe chart panel to left, you can choose special chart.

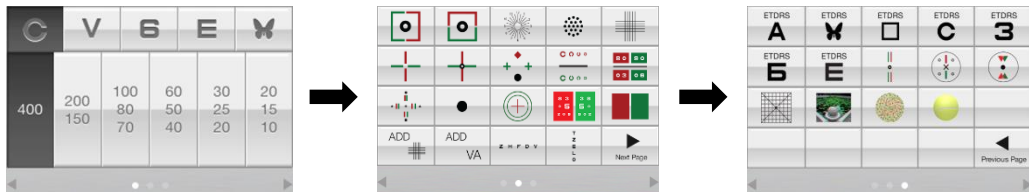

5-5-2. CONTRAST adjustment

- After click the button, you can adjust contrast by moving scroll bar.

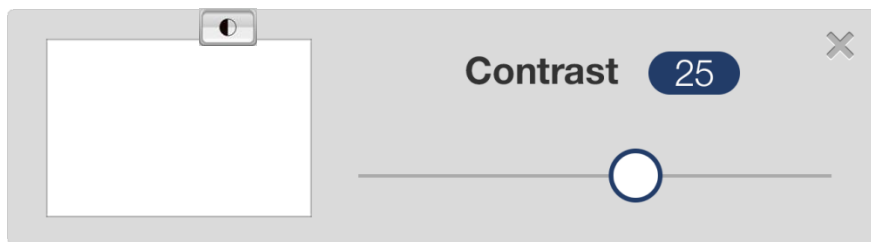

5-5-3. Amsler Grid chart.

- After click the button, you can choose Amsler grid chart.

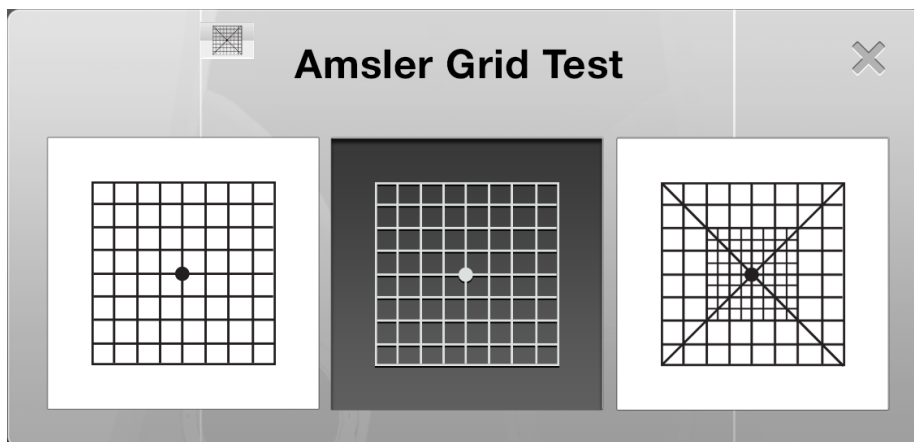

5-5-4. Binocular Balance

- After the  button, you can choose Binocular Balance chart.

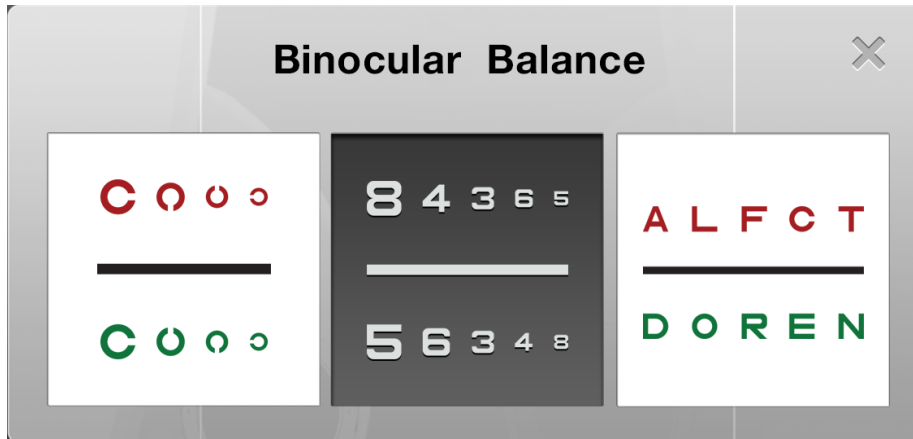

5-5-5. Clock Dial

- After the  button, you can choose Clock dial chart.

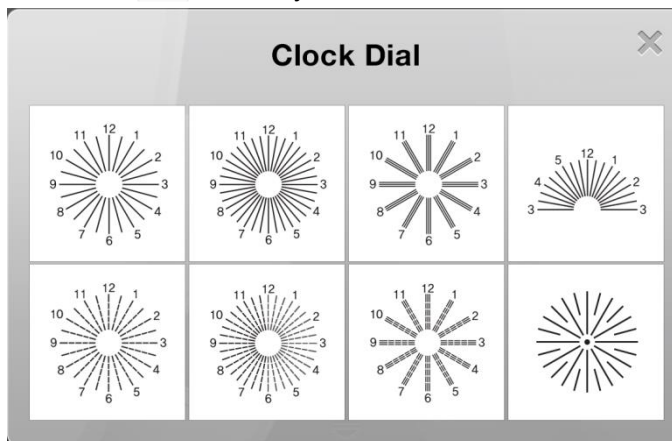

5-5-6. Color-blindness test

- After click the  button, you can choose color-blindness chart.

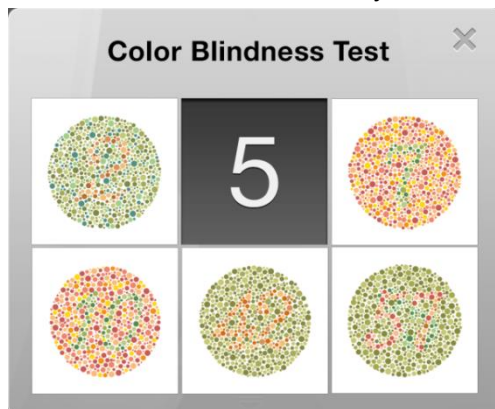

5-5-7. Dot chart.

- After click  button, you can select dot chart.

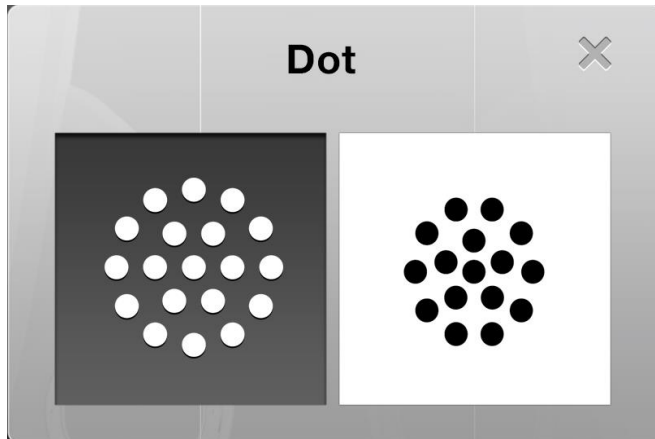

5-5-8. ETDRS chart.

- After click  button, you can select ETDRS.

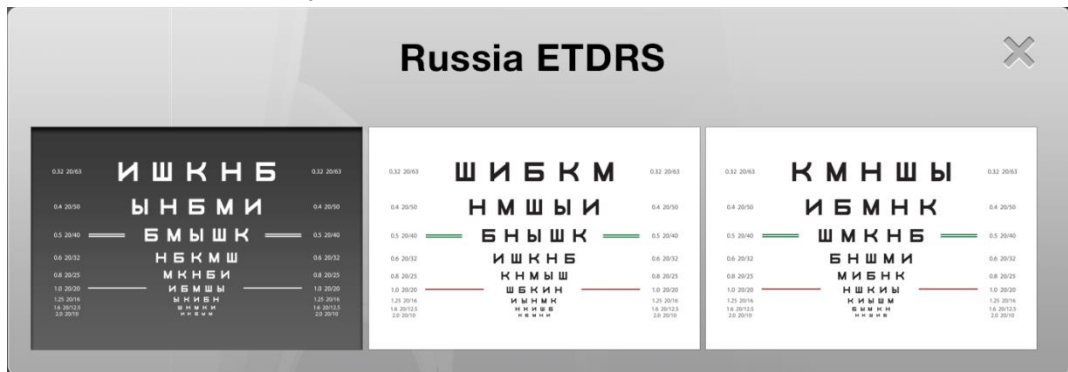

5-5-9. Phoria & Phoria Fixation

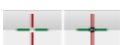
- After click  button, you can choose Phoria and Phoria with fixation.

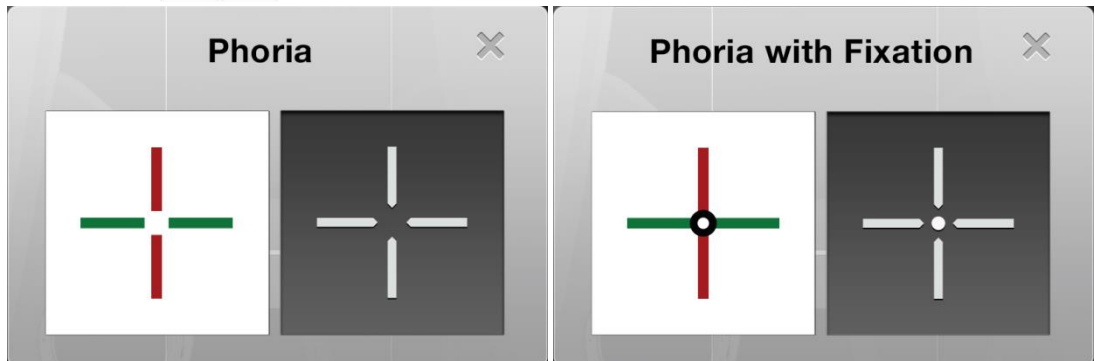

5-5-10. Red/Green Image

- If you click  the button, you can choose red/green picture.

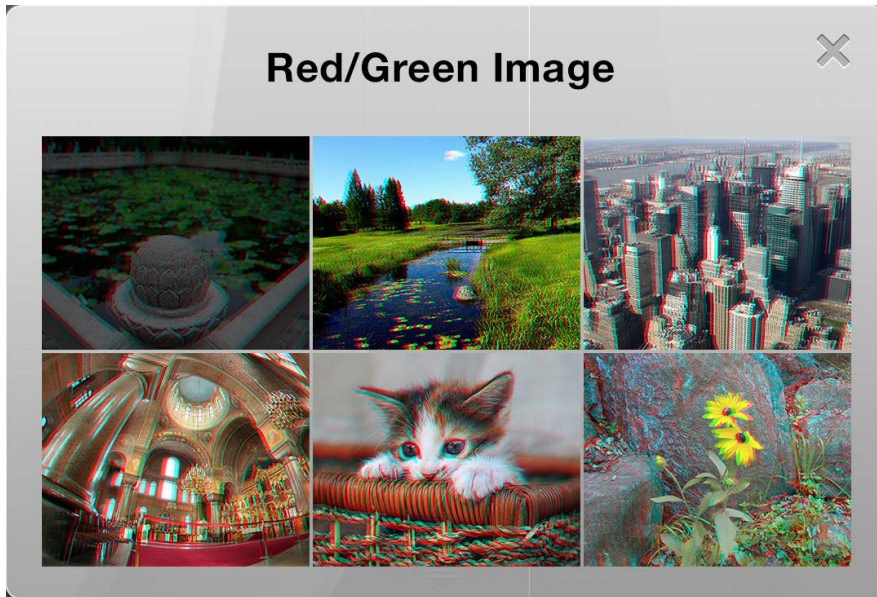

5-6. Setting on Application

- A. Click on the  button.
- B. Touch on setting menu.
- C. LCD screen during entering to setting page.

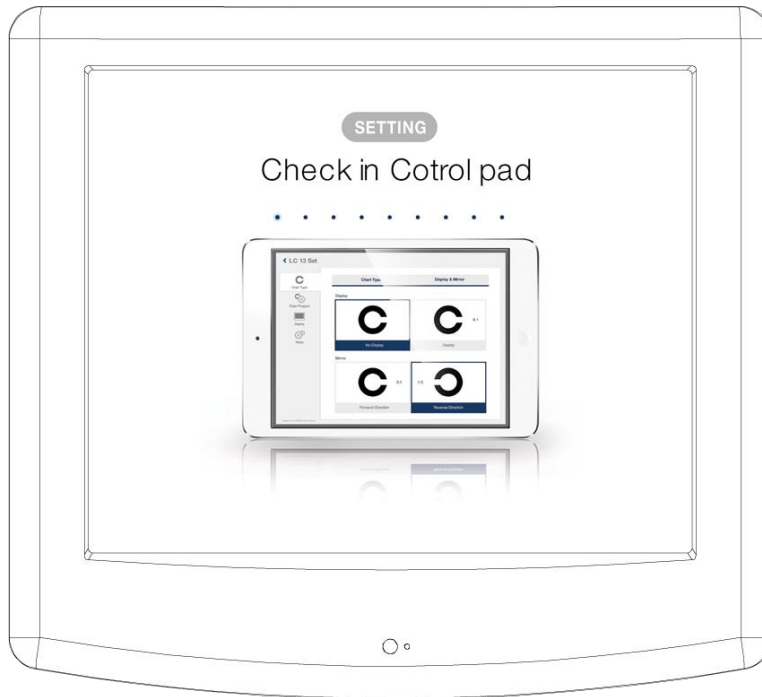

5-6-1. Chart Type

- You can select chart Type, distance marker & mirror mode.

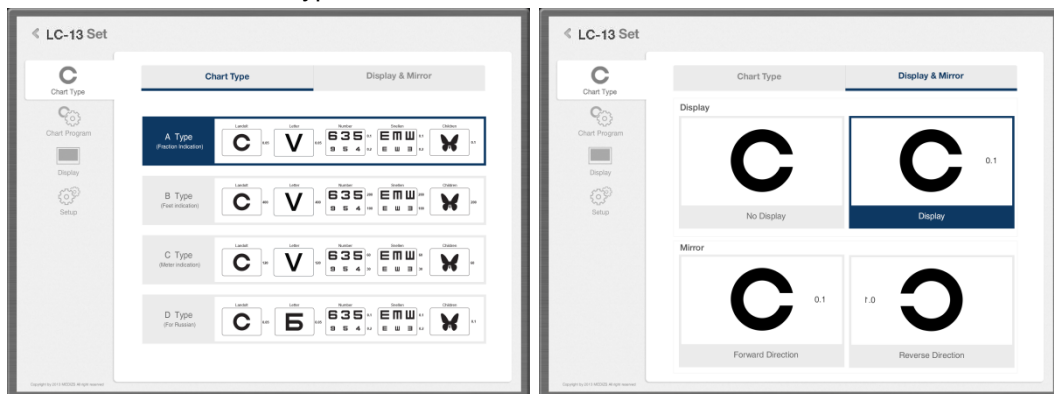

5-6-2. Program Mode

- You can delete or revise the set program by user.

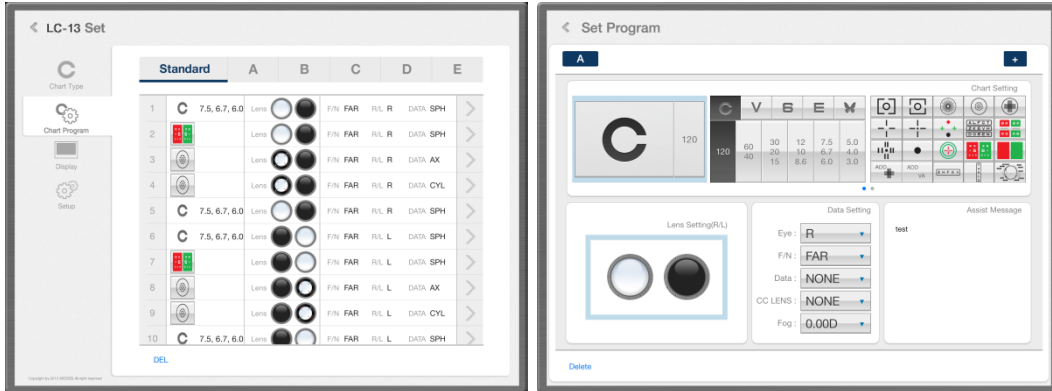

5-6-3. Display

- Red/Green: Color density of Red and Green filter can be adjusted.
- Distance: In accordance with refraction circumstance, the testing distance can be set in the range of 1.5 to 8 m in increments of 0.25 m.

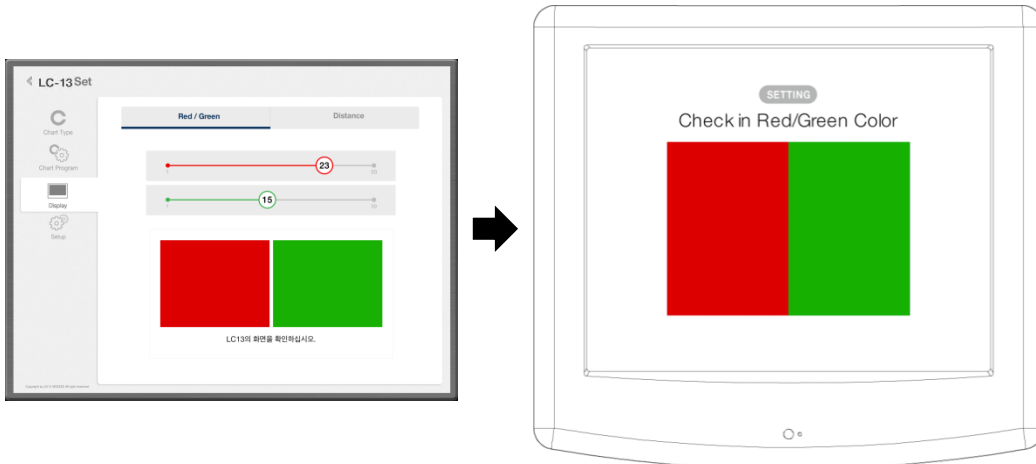

5-6-4. Setup

Set Screen saving time, Beep sound, and Screen brightness.























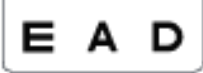



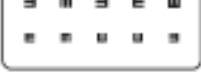

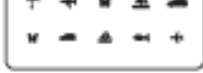

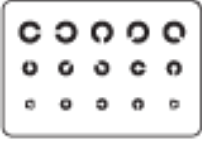
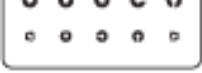





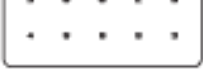

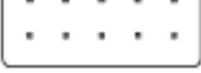

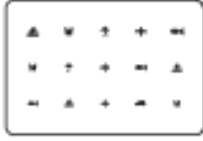
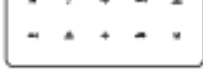

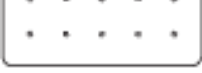

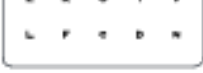

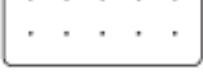

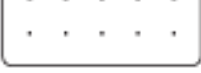

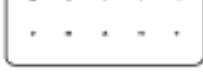







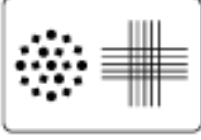





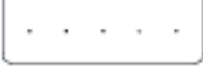



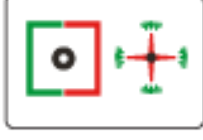

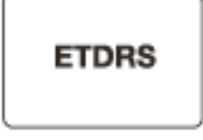
6. Chart type

- Charts applied into LC-13 are as below.













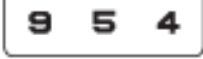









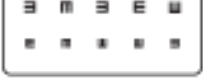

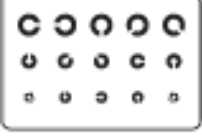









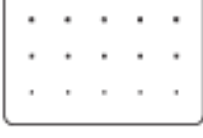
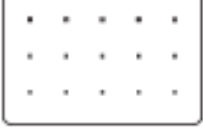
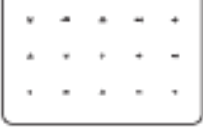

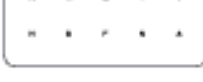

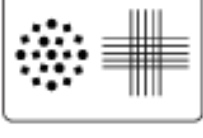







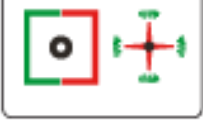

A Type (Fraction indication)

Landolt	Letter	Number	Snellen	Children
0.06	0.06	0.1 0.2 0.3	0.1 0.2 0.3	0.1
0.1 0.15	0.1 0.15	0.4 0.5 0.8	0.4 0.5 0.6 0.8	0.3 0.4 0.5 0.6
0.2 0.3 0.4	0.2 0.3 0.4	0.7 0.8 0.9	0.7 0.8 0.9	0.6 0.7 0.8
0.5 0.6 0.7	0.5 0.6 0.7	1.0 1.2 1.6	1.0 1.2 1.6	1.0 1.2 1.6
0.8 0.9 1.0	0.8 0.9 1.0	0.8 0.9 1.0	0.8 0.9 1.0	0.8 0.9 1.0
1.2 1.5 2.0	1.2 1.5 2.0	1.2 1.5 2.0	1.2 1.5 2.0	1.2 1.5 2.0
CONTRAST	ETDRS	Green circle with cross	Red 5 Green 5	Red and green cross
Red and green bars	SLIDE	Z H F D V T Z E	Red 8 0 3 Green 0 6	Red and green symbols
Black square	RANDOM			

B Type (Feet indication)

Landolt	Letter	Number	Snellen	Children
 400	 400	 200  100	 200  100	 200
 200  150	 200  150	 80  70  60	 80  70  60	 80  70  60
 100  80  70	 100  80  70	 60  40  30	 60  40  30	 60  40  30
 80  60  40	 80  60  40	 26  20  15	 26  20  15	 26  20  15
 30  26  20	 30  26  20			
 20  16  10	 20  16  10			
				
				
				

C Type (Meter indication)

Landolt	Letter	Number	Snellen	Children
 120	 120	 80  30	 80  30	 80
 80 45	 80  45	 24  21  18	 24  21  18	 24 21 18
 30 24 12	 30  24  12	 15 12 9	 16 12 9	 15 12 9
 18 16 12	 18  16  12	 7.5 8.0 4.5	 7.5 8.0 4.5	 7.5 8.0 4.5
 8.0 7.6 6.0	 8.0  7.6  6.0			
 6.0 4.5 3.0	 6.0  4.5  3.0			
				
				
				

D Type (For Russian)

Landolt	Letter	Number	Snellen	Children
0.06	0.06	0.1 0.2	0.1 0.2	0.1
0.1 0.16	0.1 0.16	0.3 0.4 0.5	0.3 0.4 0.6	0.3 0.4 0.6
0.2 0.3 0.4	0.2 0.3 0.4	0.8 0.7 0.8	0.8 0.7 0.8	0.8 0.7 0.8
0.6 0.8 0.7	0.6 0.8 0.7	1.0 1.2 1.6	1.0 1.2 1.6	1.0 1.2 1.6
0.8 0.8 1.0	0.8 0.8 1.0	1.2 1.6 2.0	1.2 1.6 2.0	1.2 1.6 2.0
1.2 1.6 2.0	1.2 1.6 2.0	1.2 1.6 2.0	ALFCT ZKEVH DOREN	1.2 1.6 2.0
CONTRAST	ETDRS	1.2 1.6 2.0	5 5	1.2 1.6 2.0
SLIDE	RANDOM	Z H F D V T Z E	8 0 9 0 0 3 0 6	1.2 1.6 2.0
RANDOM				

7. Maintenance and repair

If there's some error or malfunction on the instrument, please do self-inspection according to following instruction. If the problem still remains after self-inspection, please switch off the instrument and contact dealer.

- A. When the instrument doesn't turn on
 - Check the main fuse on the rear of the unit

- B. When the instrument turns on, but does not function:
 - Check the battery in the remote controller

8. Service Information

If the problem of device persists after the following instruction in "7.Maintenance and Repair", please contact the dealer.

Referring the name plate, please give below information to the dealer.

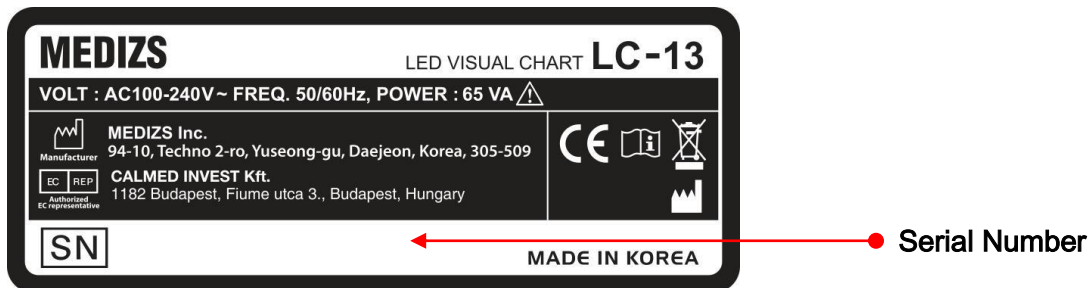

8-1. Information

- Model Name: LC-13
- Serial Number: 7 digits in the name plate
- Symptom: For fast service, please describe it as much as possible.

8-2. Supply of spare parts

- Parts of this instrument will be supplied for 6 years if it was discontinued.

9. Specification

Chart	86	
Chart types	Landolts Ring, Snellen E, Letter, Number, Children, Russian, etc.	
Mask	3 Horizontal lines 5 Vertical lines 21 Single letters	
Chart selection speed	Average 0.2 sec	
Projection distance	1.5M ~ 8.0M	
Controller	Remote controller , iPad (optional)	
Communication	Wireless(Bluetooth)	
LCD type	19 inch(SXGA) LED TFT LCD	
LCD resolution	1280(H) x 1024(V)	
Output area	376.32(H) x 301.06(V) mm	
Brightness	250 cd/m ²	
Basic accessories	Remote controller, Wall mount	
Optional accessories	Red/Green glasses	
External ports	USB A/B types. SD Card.	
OS	Windows CE 6.0	
Filter	Red/Green filter	
Power supply	AC 100 ~ 240V, 50/60Hz	
Power consumption	65VA	
Dimensions	Main body	475(W) x 432(H) x 71(D) mm 18.7(W) x 17(H) x 2.8(D) inch
	Remote controller	64(W) x 195(H) x 20(D) mm 2.5(W) x 7.7(D) x 0.8(H)inch
Weight	Main body	5(kg) / 11(lbs)
	Remote controller	180(g) / 0.4(lbs)

10. Components list

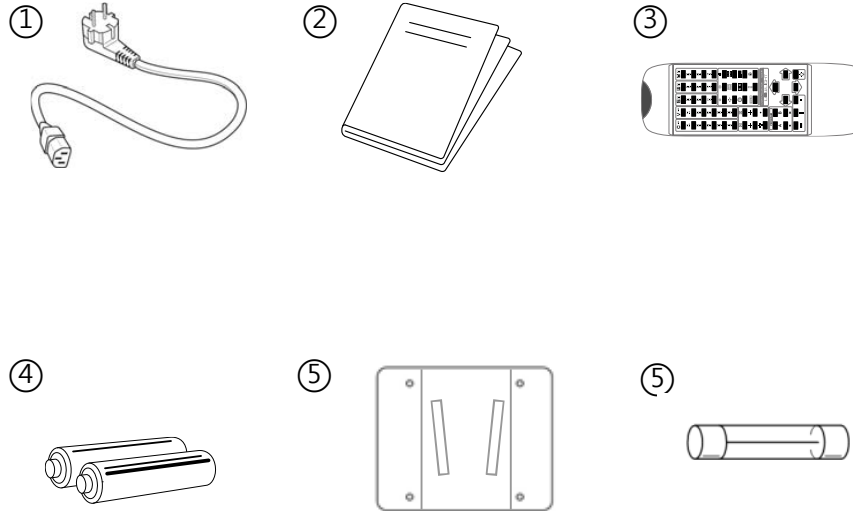

Description	Quantity
1. Power cable	1
2. Operation manual	1
3. Remote control	1
4. Batteries(AA)	2
5. Wall Mounting Bracket	1
6. Fuse	1